





# OPERATING MANUAL LUXTRONIK

 Scope of delivery, Montage,  
Electrical connections,  
Installation of sensors, Dismantling

 Software update

 Switching on / Commissioning

 Program area "Cooling"

 Program area "Service"

 Program area "Parallel mode"

Appendix



83055400kUK - 2.1

## UK

Heating- and heat pump control  
Part 2



## Please read first

This operating manual is part 2 of the 2-part operating manual for the heating and heat pump controller. Ensure that you have part 1 of this operating manual. If part 1 is missing, request it from your supplier

This operating manual provides important information on the handling of the unit. It is an integral part of the product and must be stored so that it is accessible in the immediate vicinity of the unit. It must remain available throughout the entire service life of the unit. It must be handed over to subsequent owners or operators of the unit.

Read the operating manual before working on or operating the unit. This applies in particular to the chapter on safety. Always follow all instructions completely and without restrictions.

It is possible that this operating manual may contain instructions that seem incomprehensible or unclear. In case of questions or uncertainty, contact the factory customer service department or the manufacturer's local service partner.

This operating manual is intended only for persons assigned to work on or operate the unit. Treat all constituent parts confidentially. The information contained herein is protected by copyright. No part of this information may be reproduced, transmitted, copied, stored in electronic data systems or translated into another language, either wholly or in part, without the express written permission of the manufacturer

## Symbols



Information for users.



Information or instructions for qualified technicians and authorised service personnel.



### **DANGER**

Indicates a direct impending danger resulting in severe injuries or death.



### **DANGER**

Indicates danger to life due to electric current!



### **WARNING**

Indicates a possibly dangerous situation that could result in severe injuries or death.



### **CAUTION**

Indicates a possibly dangerous situation that could result in medium or light injuries.



### **IMPORTANT**

Indicates a possibly dangerous situation, which could result in property damage.



### **NOTE**

Emphasized information.



### **ENERGY SAVING TIP**

Indicates suggestions that help to save energy, raw materials and costs.



Users and qualified technicians can set data.  
Access: User.



Authorized installer can set data; password required.  
Access: Installer.



Authorised service personnel can set data. Access via USB stick only.  
Access: After sales service.



Factory pre-setting, no data change possible



Procedural instructions: single step action prompt.

1., 2., 3., ... Numbered step within a multi-step instruction for action. Adhere to the given sequence.



List.



Prerequisite for an action.



Reference to further information elsewhere in the operating manual or in another document.



# Contents

PLEASE READ FIRST .....2  
 SYMBOLS .....2



**SCOPE OF DELIVERY, MONTAGE, ELECTRICAL CONNECTIONS, INSTALLATION OF SENSORS, DISMANTLING**

**SCOPE OF DELIVERY** .....5  
 Installed control scope of supply .....5  
 Wall control scope of supply .....5

**MONTAGE**.....5  
 Assembly of the installed control.....5  
 Assembly of the wall control.....5  
 Air/Water outdoor units standard.....5  
 Air/Water outdoor units professional (LWP).....5

**ELECTRICAL CONNECTIONS**.....6  
 Installation of the Wall-control .....6  
 Air/Water outdoor units standard.....6  
 Air/Water outdoor units professional (LWP).....6

Control unit variants .....8  
 Variants of the motherboard.....8  
 Assembly and Installation of sensors .....9  
 External sensor.....9  
 Hot water sensor.....9  
 External return flow sensor..... 10

**DISMANTLING** ..... 10

**SOFTWAREUPDATE / -DOWNGRADE**..... 10

**SWITCHING ON / COMMISSIONING**..... 10

**STARTUP GUIDE** ..... 12  
 Fix startup parameters..... 13  
 Reset start-up parameters..... 13

**EMERGENCY MODE**..... 14



## PROGRAM AREA "COOLING"

SELECT PROGRAM AREA ..... 15  
 SETTING THE MODE OF OPERATION "COOLING" ..... 15  
 SET TEMPERATURES..... 16  
 SET PARAMETERS ..... 16  
 COOLING BASED ON SET TEMPERATURE OR  
 DEPENDING ON OUTDOOR TEMPERATURE .....17  
 ENABLE ACTIVE COOLING .....17



## PROGRAM AREA "SERVICE"

SELECT PROGRAM AREA ..... 18

**QUERY INFORMATION**..... 18  
 Query Temperatures..... 18  
 Query inputs..... 19  
 Query outputs ..... 19  
 Query elapsed times..... 20  
 Query operating hours..... 20  
 Query error memory..... 20  
 Query switch offs..... 20  
 Query the system status ..... 21  
 Query energy monitor ..... 21  
 Query heat quantity..... 21  
 Query energy input..... 22  
 Query the history and exporting the history ..... 22  
 Query building services management system (BMS)..... 22  
 Query Smart..... 23  
 Query InfoLog..... 23  
 Query Inverter ..... 23  
 Query EventLog..... 23

**MAKING SETTINGS**..... 24  
 Determine data access..... 24  
 Calling up preset program ..... 24  
 Determining temperatures ..... 24  
 Hot gas utilisation / desuperheater..... 27  
 Determining priorities ..... 27  
 Determining system setting..... 27  
 Ventilating the system ..... 31  
 Fix startup parameters ..... 32  
 Back up error memory externally..... 32  
 Efficiency pump..... 32  
 Enter serial number ..... 33  
 RBE – room control unit..... 33  
 Additional heating generator..... 33  
 Inverter ..... 34  
 FlexConfig..... 35  
 Silent Mode ..... 35  
 Pump flow lead time..... 36  
 Smart..... 36  
 Smart Grid..... 36  
 Operating states..... 37  
 Set decrease / increase ..... 37  
 Terminal diagrams Smart Grid ..... 38

SELECTING LANGUAGE OF THE SCREEN DISPLAY..... 38

DETERMINING DATE AND TIME ..... 38

SCREED HEATING PROGRAM ..... 39  
 Setting temperatures and time intervals..... 39  
 Starting screed heating program ..... 40  
 Manually terminating screed heating program..... 40

HEATPUMP CONFIGURATION ..... 41

STARTUP GUIDE ..... 41

RESET START-UP PARAMETERS..... 41

DATA LOGGER ..... 41

CONTROL PANEL ..... 41  
 Adjusting the contrast of the  
 control unit display ..... 41  
 Web server..... 41



Remote maintenance.....	41
Switch on the remote maintenance function .....	42
Check connection.....	42
Error causes with connection problems.....	42
Heatpump24.com.....	42



## PROGRAM AREA "PARALLEL MODE"

BASIC INFORMATION .....	44
Switching on and off for LWP heat pumps.....	44
Switching on and off for Hybrox heat pumps.....	44
Broken connection.....	44
Connection.....	45
Additional heat generator .....	46
Master – heating mode .....	46
Slave –preparing domestic hot water.....	46
Mixing curcuits.....	46
Energy monitor .....	46
SELECT PROGRAM AREA .....	46
IP-ADRESS .....	47
Set the network addresses .....	47
EXTERNAL RETURN FLOW SENSOR .....	47
SETTING ON THE MASTER .....	48
Network.....	48
Search for Slaves.....	48
Status of the master .....	48
Set parameters .....	48
Service Menu.....	49

## APPENDIX

ERROR DIAGNOSIS / ERROR MESSAGES.....	50
Acknowledging a fault.....	54
Flashing codes on controller board.....	54
TECHNICAL DATA .....	55
Installation .....	55
Outputs .....	55
Inputs.....	55
Connections.....	55
Interfaces.....	55
Protection class.....	55
Temperature sensor characteristic curve.....	55
Overview: Defrost cycle, Air defrost, Flow Max.....	56
Sensor measuring range.....	56
SYSTEM SETTING DURING COMMISSIONING.....	57
ABBREVIATIONS (SELECTION) .....	61



## Scope of delivery

### **NOTE**

Function-critical temperature sensors (return, inlet, hot gas) are installed in the heat pump and are not part of the scope of supply of the heating and heat pump control.

The heating and heat pump control is supplied in two variants. The variant supplied is dependent on the device type of the heat pump to the controlled.

### INSTALLED CONTROL SCOPE OF SUPPLY

In the case of devices for internal mounting, the motherboard of the heating and heat pump control is integrated in the relevant device as an "installed control". The "installed control" scope of supply is included in the scope of supply of the device for internal mounting.

- Heating and heat pump control, consisting of motherboard (with terminals) and control unit (with status display, screen and "rotary pushbutton")
- External sensor for the surface mounting
- Operating manual (in two parts)
- Brief description of the heat pump control.

### **NOTE**

Please fasten brief description in the vicinity of the device.

### WALL CONTROL SCOPE OF SUPPLY

In the case of devices for external mounting, the motherboard of the heating and heat pump control is not integrated in the relevant device but in the wall control.

- Heating and heat pump control for surface mounting, consisting of motherboard (with terminals), housing and control unit (with status display, screen and "rotary pushbutton")
- Wall mounting materials (drill template, screws, dowels for solid masonry)
- External sensor for the surface mounting
- Operating manual (in two parts)
- Brief description of the heat pump control

### **NOTE**

Please fasten brief description in the vicinity of the device.

1. Check the supplied product for signs of external damage during delivery.
2. Check that nothing is missing from the scope of supply. Immediately submit a complaint in the event of delivery defects.

## Montage

### ASSEMBLY OF THE INSTALLED CONTROL

In the case of devices for internal mounting, the motherboard of the heating and heat pump is integrated in the electrical switch cabinet of the device.

- Operating manual of your heat pump, assembly of the control unit

### ASSEMBLY OF THE WALL CONTROL

Air/Water outdoor units standard

- Operating Manual wall-mounted controller

Air/Water outdoor units professional (LWP)

For all work to be carried out:



### **NOTE**

Observe the locally-applicable accident prevention regulations, statutory provisions, ordinances and directives.



### **WARNING**

**Only qualified technicians may mount the heating and heat pump control.**

1. Position the drill template at the point where the heating and heat pump control is to be located.



### **IMPORTANT**

Check the potential mounting location for concealed wiring. Position the drill template in such way that no concealed wiring can be drilled into or damaged during the subsequent assembly work.



### **NOTE**

You need to ensure  $\geq 2$  cm free space to the right and left of the drill template, so that there is enough space for the side fastening screws of the housing cover.

2. Fix drill template onto the wall with adhesive tape, drill holes ( $\varnothing 6$  mm, depth  $\geq 55$  mm).

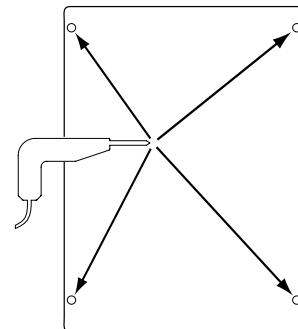

3. Take drill template off the wall, insert dowels in the holes, screw in screws (spacing from the substrate to the screw head approximately 10mm).



**NOTE**  
The wall mounting material included in the scope of supply requires solid masonry.

**IMPORTANT**  
Ensure that the screws are firmly in the substrate.

- Loosen right and left fastening screw of the housing cover for the heating and heat pump controller.

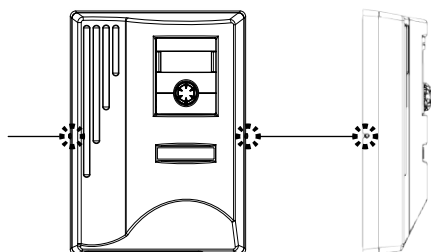

- Remove housing cover and set aside in a safe place.
- Hang the heating and heat pump control into the screws on the wall. Tighten the screws.

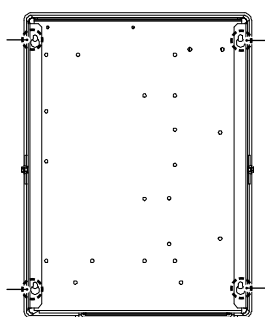

1 Rear view

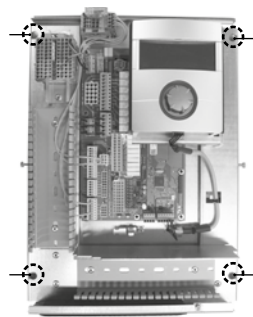

2 Front view

- If the electrical installation is not to be carried out immediately afterwards: Put the housing cover back on and tighten the side fastening screws.

## Electrical connections

**DANGER**  
Danger of fatal injury due to electric current!  
Electrical connections may be installed only by qualified electricians.  
Before opening the unit, disconnect the system from the power supply and secure it from being switched back on!

**WARNING**  
During installation and while carrying out electrical work, comply with the relevant EN-, VDE and/or local safety regulations.  
Comply with technical connection requirements of the responsible power supply company (if required by the latter)!

Follow the information in the operating manual of your heat pump for establishing the electrical connections.

- Operating manual of your device, "Electrical Connections", "Terminal Diagram" and "Circuit Diagrams" for your device type

### INSTALLATION OF THE WALL-CONTROL

Air/Water outdoor units standard

- Operating Manual wall-mounted controller

Air/Water outdoor units professional (LWP)

- If not yet carried out: Remove housing cover of the heating and heat pump control.

- section "Montage", "Assembly of the wall control", instructions 4. – 5.

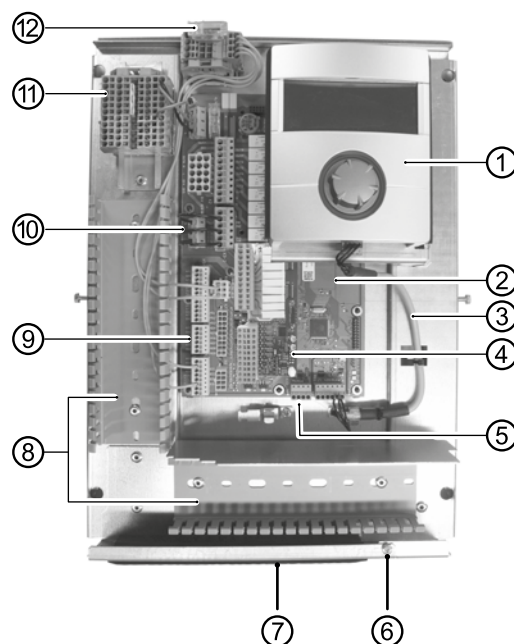

- Control unit
- Motherboard of the heating and heat pump control
- LIN-BUS communication cable between motherboard and control unit (wired in the factory)
- Extension board 2.1
- Terminal block (X10 Modbus) for BUS cable to the outdoor unit
- Fastening screw of the folding bracket
- Cable entry with folding bracket
- Cable ducts with covers (covers now shown here in the figure)
- TRL return sensor terminal (on NTC8)
- EVU bridges (must be removed when connecting a floating contact)
- Terminal block for 1~/N/PE/230 V voltage supply
- Connection for circulation pump PWM control signal

- Loosen fastening screw of the folding bracket for the cable entry and pull the folding bracket downwards until it is possible to fold away upwards. Fold folding bracket upwards and away to the side.
- Remove covers from the cable ducts.
- Connect the BUS communication cable, which leads to the heat pump, to terminal block X10 of the controller board. Then route the BUS communication cable downwards and through the cable ducts and through the cable entry to the outside.





5. Connect the 230 V voltage supply line to the voltage supply terminal block.

**NOTE**

The terminal block has spring-type terminals to maximum 2.5 mm<sup>2</sup>.  
Insulate the cable jacket so that the jacket end is located between the sealing lip and cable duct.

6. Connect the 230 V power supply for the outdoor unit to the terminal block and route it downwards through the cable ducts and through the cable entry to the outdoor unit outside.
7. Connect the PWM control signal for the circulation pump to the terminal block X10.
8. A separately packed return sensor (TRL) with appropriate installation materials is enclosed with the air/water heat pump for outdoor installation. Use cable ties and heat transfer compound to fix the return sensor to the return (heat-conducting pipe) to the heat pump as shown in the figure and connect (to NTC8) as shown in the circuit diagram.

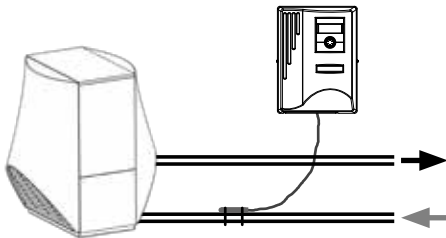

Basic wiring:

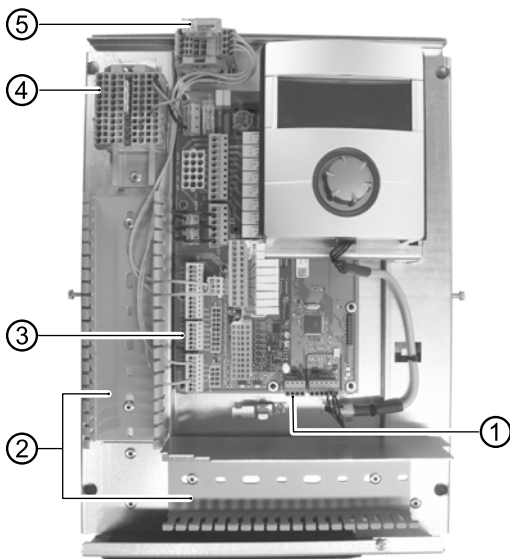

- 1 Connect BUS communication cable
- 2 Laying cables in the cable ducts
- 3 Connect TRL return sensor (on NTC8)
- 4 Connect 1~/N/PE/230 V power supply for wall-mounted controller and outdoor unit
- 5 Connect PWM control signal for circulation pump

9. If necessary, install additional external cables.
- Instruction manual for your appliance, "Connection layout" and "Circuit diagrams" for your appliance type

**NOTE**

The inputs and outputs on the motherboard are assigned as shown on the device's terminal connection diagram. In addition, the assignment is shown on the inside of the housing of the wall-mounted controller.

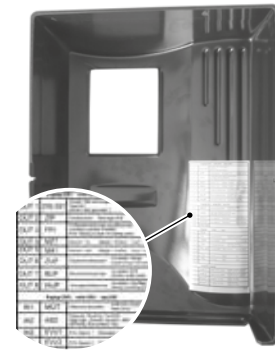

10. Place covers on the cable ducts. Swivel folding bracket of the cable entry back into the initial position and allow to latch into place below the fastening screw. Tighten fastening screw.
11. Put the housing cover back on and tighten the side fastening screws.

**! IMPORTANT**

Route all lines that you connect to the heating and heat pump control outside the heating and heat pump in a cable duct (necessary for strain relief; to be realised at the customer).

**! IMPORTANT**

The BUS communication cable must be laid at a spacing > 10 cm from other cables. Therefore, lay with the appropriate spacing in a separate cable duct.

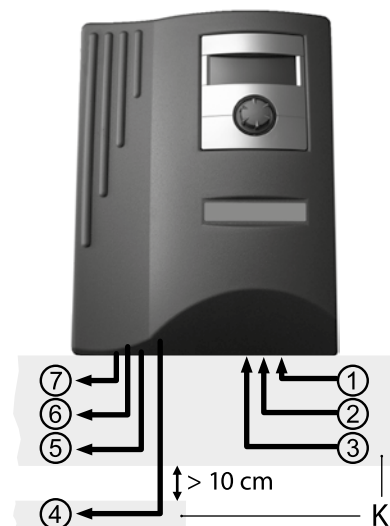

- 1 1~/N/PE/230V power supply (to the terminal block); cable cross-section max. 2.5 mm<sup>2</sup>
- 2 other 230 V inputs (electricity outage, ...)
- 3 Sensor cables including the TRL return sensor on the return to the heat pump
- 4 BUS communication cable to the outdoor unit
- 5 other 230 V outputs (circulation pumps, mixers, ...)
- 6 PWM control signal for circulation pump
- 7 230 V power supply to the outdoor unit
- K Cable ducts



## CONTROL UNIT VARIANTS

Depending on the heat pump type, one of these models of the control unit is included in the scope of delivery:

Variant 1<sup>\*)</sup>

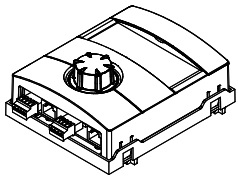

Variant 2<sup>\*)</sup>



<sup>\*)</sup> Variant device-dependent

Assignment of the plugs on the underside of the control unit:

→ Operating manual of your heat pump.

## VARIANTS OF THE MOTHERBOARD

Depending on the heat pump type, the heating and heat pump controller is equipped with one of the following motherboards:

HZ I/O motherboard

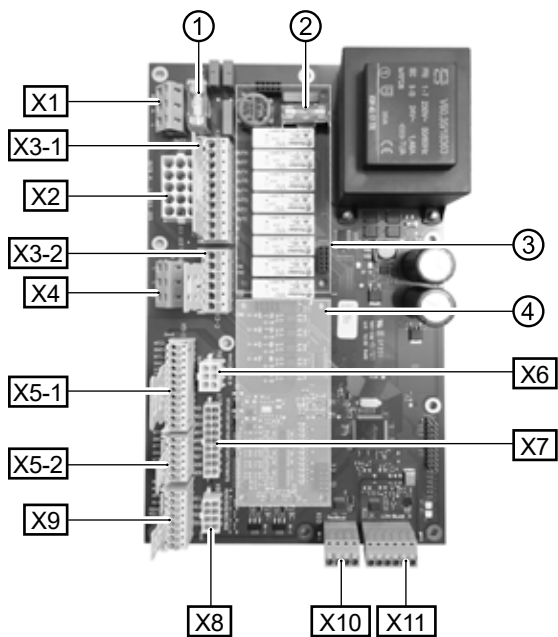

- 1 Fuse for relay outputs 6,3 AT
- 2 Fuse for transformer 1,6 AT
- 3 Slot for extra board MLRH
- 4 Slot for expansion board
- X1 Terminal block: Control voltage
- X2 Terminal block (is not equipped / unused in the standard version)
- X3-1 Terminal block: 230 V outputs
- X3-2 Terminal block: 230 V inputs
- X4 Terminal block: 230V distribution (continuous current)
- X5-1 Terminal block: External sensor inputs
- X5-2 Terminal block: External sensor inputs
- X6 Terminal block: Connection for circulation pump PWM
- X7 Terminal block (is not equipped / unused in the standard version)
- X8 Terminal block (is not equipped / unused in the standard version)
- X9 Terminal block: Analog outputs and inputs
- X10 Terminal block: Modbus interface
- X11 Terminal block: LIN-Bus interface (for control unit)

I/O MAX motherboard

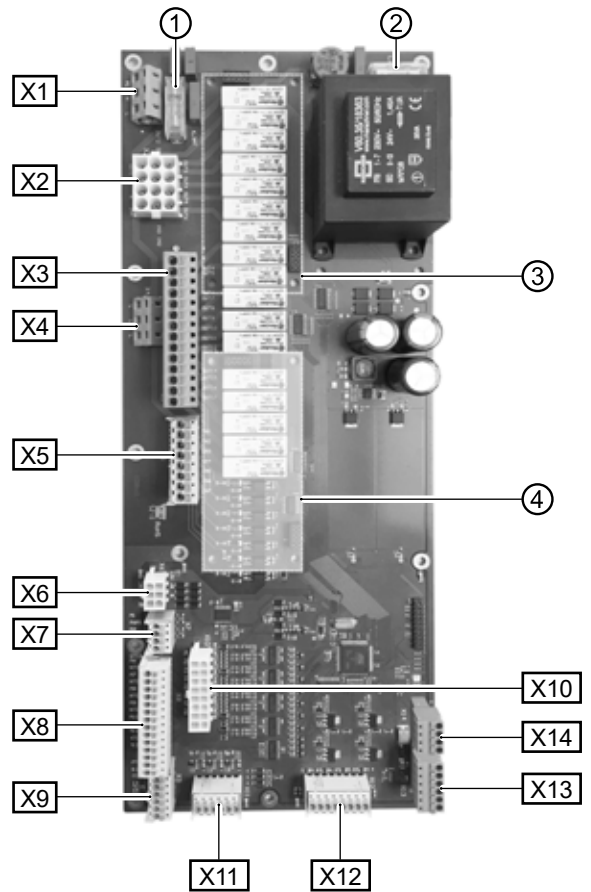

- 1 Fuse for relay outputs 6,3 AT
- 2 Fuse for transformer 1,6 AT
- 3 Slot for extra board MLRH
- 4 Slot for expansion board
- X1 Terminal block: Control voltage
- X2 Terminal block: Interne 230 V Ein- und Ausgänge
- X3 Terminal block: 230 V outputs
- X4 Terminal block: 230V distribution (continuous current)
- X5 Terminal block: 230 V inputs
- X6 Terminal block: Connection for expansion valve or circulation pump PWM
- X7 Terminal block: Connection for circulation pump PWM
- X8 Terminal block: External sensor inputs
- X9 Terminal block: External sensor inputs
- X10 Terminal block: Internal sensor inputs
- X11 Terminal block: Analog inputs
- X12 Terminal block: Analog outputs
- X13 Terminal block: LIN-Bus interface (for control unit)
- X14 Terminal block: Modbus interface





## ASSEMBLY AND INSTALLATION OF SENSORS

### External sensor

The external sensor (protection class IP 67) is a function-critical accessory and included in the scope of supply.

#### **NOTE**

If the external sensor is not installed or defective, the heating and heat pump control automatically sets the external temperature to -5 °C. The status display of the control unit lights up red, the screen of the control unit reports an error.

#### **IMPORTANT**

Mount the external sensor on the north or northeast side of buildings. The sensor must not be exposed to direct sunlight. The cable gland must point to the base.

1. Open the housing of the external sensor and align  $\geq 2$  m over the base of the fastening point.

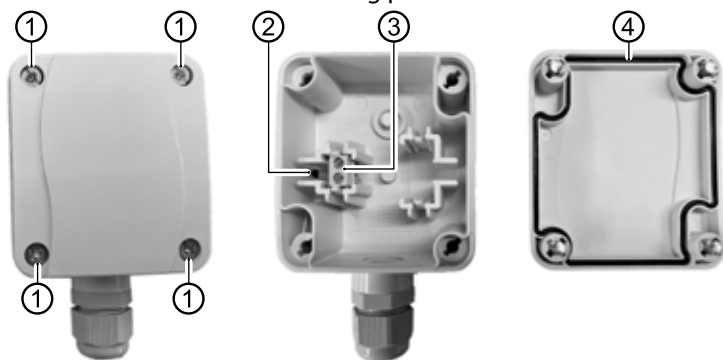

- 1 Quick-release screws
- 2 NTC sensor element 2.2 k $\Omega$  at 25 °C
- 3 Cable clamps
- 4 Housing sealing in housing cover

2. Mark the fixing holes on the fixing point and drill them into the fixing point. Insert dowels and screw the housing of the external sensor to the wall.

#### **NOTE**

Dowels and screws for fastening the external sensor are not included in the scope of supply.

3. Loosen cable gland and lead a 2-wire cable ( $\varnothing$  5 - 9,5 mm, cross section  $\leq 1.5$  mm<sup>2</sup> per wire, cable length  $\leq 50$  m) through the cable gland into the housing.
4. Fit the cable wires with wire end sleeves, place them on the cable clamps of the external sensor and tighten them with a torque of 0.5 Nm.
5. Tighten cable glands with a torque of 2.5 Nm and close the housing of the external sensor. Ensure that the housing seal and the sealing surfaces are clean and that the housing seal is in the correct position.

#### **IMPORTANT**

No moisture may be trapped in the housing. If necessary, completely dry the inside of the housing before mounting the housing cover.

Ensure that the tightness of the housing is guaranteed by mounting it tension-free and that no water can penetrate the housing of the external sensor at any time (for instance during the construction phase).

### Dimensional drawings

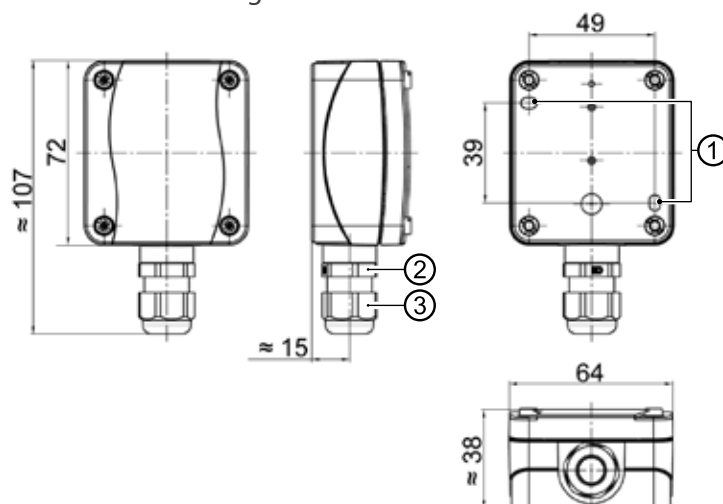

All dimensions in mm.

- 1 Fastening holes ( $\varnothing$  4,3)
- 2 Cable gland M16 x 1,5
- 3 Cable gland SW 20

### Hot water sensor

The domestic hot water sensor is an optional accessory and only functionally-relevant for a separate domestic hot water tank. You may only use domestic hot water sensors which have been approved by the manufacturer of the heat pump.

#### **IMPORTANT**

The domestic hot water tank must be filled before connecting the domestic hot water sensor to the heating and heat pump control.

If not already prepared at the factory, mount the domestic hot water sensor ( $\varnothing = 6$  mm) on the halfway level of the domestic hot water tank – and always above the internal heat exchanger of the domestic hot water tank.

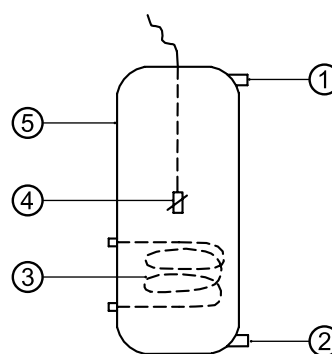

- 1 Domestic hot water connection
- 2 Cold water connection
- 3 Heat exchanger
- 4 Domestic hot water sensor ( $\varnothing = 6$  mm)
- 5 Hot-water tank



## External return flow sensor

The return flow sensor (optional accessory) is functionally-relevant for hydraulic integration of an isolating tank (multifunction tank). This has to be installed as follows:

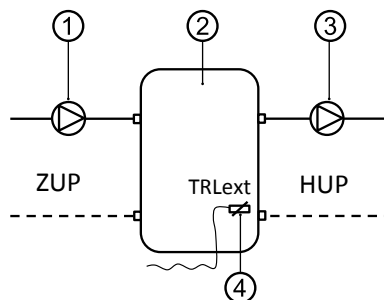

- 1 Separation or multi-functional storage tank
  - 2 Circulation pump in the separation storage tank (heat pump circuit)
  - 3 Circulation pump from the separation storage tank (heating circuit)
  - 4 External return sensor ( $\varnothing = 6 \text{ mm}$ )
- ZUP Charging loop, heat pump  
HUP Discharging loop, heating circuit

Connect the return flow sensor coming from the isolating tank to the circuit board of the heating and heat pump control.

## Dismantling



### DANGER

**Danger of fatal injury due to electric current!**  
Electrical connections may be installed only by qualified electricians.

Before opening the unit, disconnect the system from the power supply and secure it from being switched back on!

## Softwareupdate / -downgrade

Software updates/downgrades can be carried out via the USB interface on the control unit of the heating and heat pump controller.

1. Expose the USB interface on the control unit.  
→ Part 1 of the controller manual, program area "Service", section "Basic Information on the operation"
2. Insert a USB stick with the software into the USB interface and follow the on-screen instructions.

### ! IMPORTANT

Only install updates/downgrades that are cited as "valid updates" ("Gültiges Updates") in the screen list.

## Switching on / Commissioning

When switching on the controller voltage or after a restart of the heating and heat pump controller (reset), a self-test is carried out to check whether the basic components of the heat pump system are available.

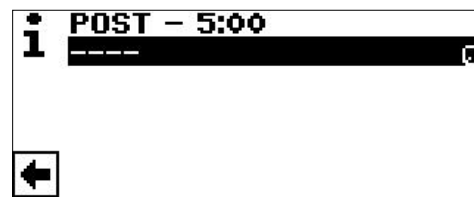

The components displayed vary depending on the heat pump type.

The self-test (POST = Power on startup) can take up to 5 minutes (Time-out).

Once all the basic components of the system are detected within 5 minutes, the system is ready for operation.



### NOTE

If the self-test fails, an emergency mode is activated, if the necessary components have been detected.

→ page 14, "Emergency mode"

If the system is ready for operation but not yet configured (initial switching on), then the language selection is displayed first.

→ Select the display language: part 1 of the controller manual, section "Basis information on the operation".



### NOTE

The language must be confirmed.



Then click on the navigation arrow in the language display.

A screen may then appear prompting you to enter a hydraulic code. In this case, enter and confirm the hydraulic code. If a hydraulic code is given, do not change this hydraulic code, but only confirm it.



### NOTE

The hydraulic code is affixed to the hydraulic unit / to the wall-mounted controller.



### NOTE

The hydraulic code can be read later in the "System status" menu. If necessary, it can be changed there.

→ page 21, "Query the system status"



The following display then appears:



The question always appears when the controller voltage is switched on, provided it has been interrupted for > 20 hours.

If the date and time are correct, select and click . Otherwise, select and click , set the correct date, time and time zone and save. Then select and click on the navigation arrow in the display.

After that a security question appears:

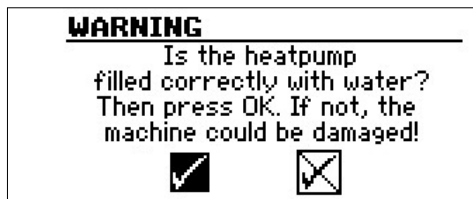

The security question always appears when the controller voltage is switched on or after a restart of the heating and heat pump controller (reset). This screen is no longer displayed if the heat pump or ZWE1 has more than 10 operating hours.

No ZWE (additional heating generator) is released by the controller until the display is confirmed with .

**NOTE**  
No heat generator runs during a cold start of air/water heat pumps.

**IMPORTANT**  
The unit can be damaged if the display is confirmed with , although the system is not properly filled.

For brine/water heat pumps it is necessary to select which heat source fluid is to be used.

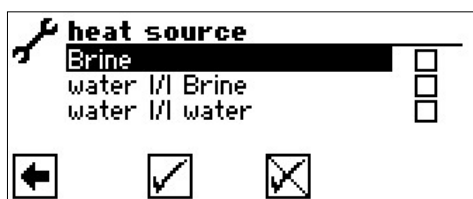

**Brine**  
Must be selected if the heat pump is operated with a brine-water mixture (= standard). Whether probes or surface collectors are used is irrelevant.

If there is an **intermediate heat exchanger** on the heat source side:

**Water /l Brine**

Must be selected if water is used as the heat source medium on the primary side of the intermediate heat exchanger and a brine-water mixture is used on its secondary side.

**Water /l Water**

Must be selected if water is used as the heat source medium on both the primary and secondary sides of the intermediate heat exchanger. For the water/water setting the heat source inlet temperature must be at least 7°C or higher.

**! IMPORTANT**

Performance-controlled brine/water heat pumps with refrigerant R407C shall only be operated on the secondary side of the intermediate heat exchanger and not with water as the heat source medium. Therefore, the menu entry "Water /l Water" is not visible in the display with performance-controlled brine/water heat pumps with refrigerant R407C.

The minimum temperature of the heat source (min. heat source temp) will be set automatically depending on the selected medium.

→ page 57, "System setting during commissioning", "min. heat source temp"

**NOTE**  
If no heat source is selected and the enquiry is only answered by navigating to and selecting , "Brine" is automatically set as the heat source. A subsequent change of the heat source medium as well as "T-HS min" is only possible with customer service access.

If this screen



is then displayed, disconnect the heating and heat pump controller from the power supply, check the 3-pole cable for the BUS connection and rectify any faults found.

After that, the navigation screen appears.

**NOTE**  
With some devices, the compressor is now heated initially. The heating phase until the compressor starts can take several hours when starting up for the first time. With dual air/water heat pumps the flow is monitored while the pump is running. If the flow is not ok, the heat pump does not start up and no error is displayed. To this end, check the ASD input, if it is not set to ON the flow is too low.

→ page 19, "Query inputs"



So long as the heat pumps have not yet been configured, the "GO" symbol flashes at the top right of the navigation screen.



Navigating to and clicking on "GO" calls up the startup guide. This assistant will guide you through the most important settings of the regulator during initial commissioning.

After the initial commissioning has been completed, the "GO" symbol will no longer be displayed.

→ page 12, "Startup guide" and page 13, "Reset start-up parameters"

If you do not wish to use the startup guide, first make the settings required for your system in the "System settings" menu (→ page 27, "Determining system setting").

Then set the desired temperatures (→ page 24, "Determining temperatures").

Then make all other settings that are necessary for the conditions of your installation.

## Startup guide

If the startup guide is not called up via the flashing "GO" symbol in the navigation screen, this can be done in the "Service" program area.

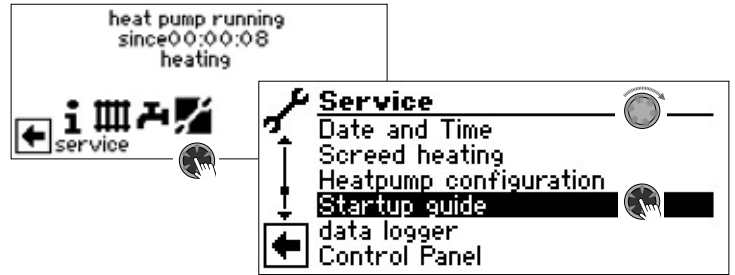

You will be guided step-by-step through several selection options used to set up your heat pump.

For example:

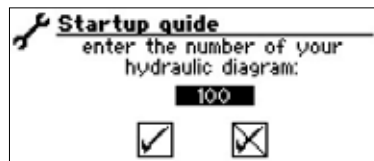

For the number of the control setting, please refer to the hydraulic diagrams we have published.



Further queries will follow.



For more information on the commissioning assistant, please refer to the corresponding sections in this operating manual.



### NOTE

As soon as the startup guide has been executed once, the menu item "Reset start-up parameters" appears on the display instead of the "Startup guide" menu item.



## FIX STARTUP PARAMETERS

With installer or customer service access, it is possible to save the settings made during commissioning (= startup guide). This allows you to quickly and easily reset the system to the status it had at startup.

The data is stored on the circuit board of the control unit.

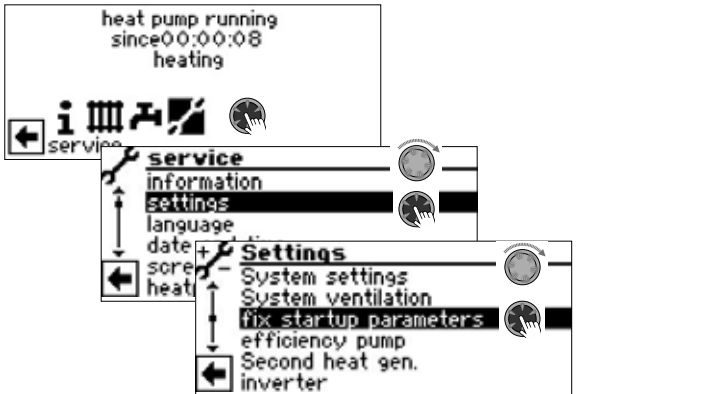

Follow the instructions on the screen and save the settings.

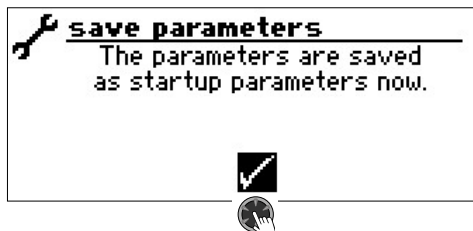

You can also save the settings to an external USB stick.

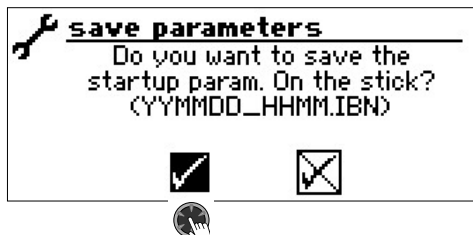

## RESET START-UP PARAMETERS

If your heat pump was commissioned by an authorised customer service partner and the startup parameters have been stored, you can use this menu item to restore these parameters.

This may be helpful if settings have been changed and led to a system malfunction. Please Notice that all settings such as heating curves, system settings, set values will be reset to the values applicable at commissioning.

The programmed switching times are not affected by this.

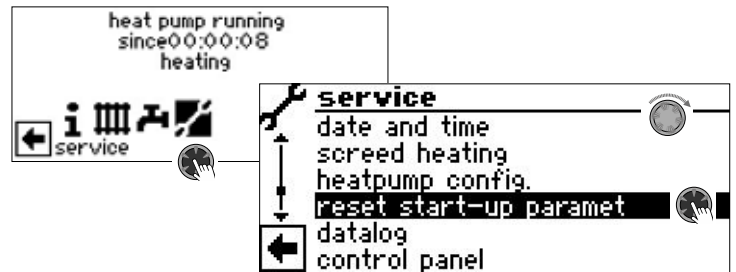

You will be guided through the following menu items:

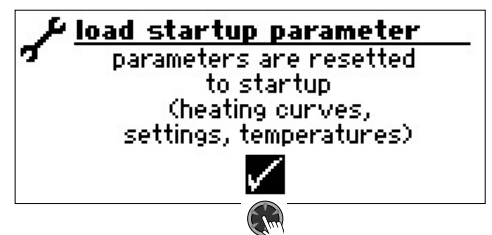
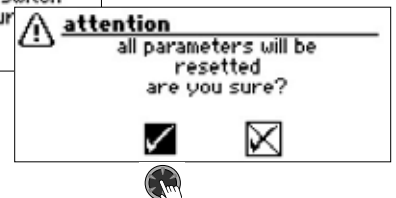
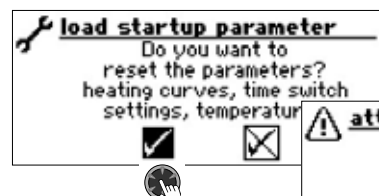



## Emergency mode

The emergency mode provides heating operation and domestic hot water preparation as well as the frost protection function and the screed heating program even if, after switching on the controller voltage and during the self-test (POST Screen)

- one or more basic system components were not detected,
- at least the system components required for the emergency mode were detected.

The emergency mode is activated automatically.

### NOTE

For units where a hydraulic code must be entered during commissioning, the emergency mode can only start if this hydraulic code has been entered.

A connection error is first displayed on the screen of the heating and heat pump controller.

Im Bildschirm des Heizungs- und Wärmepumpenreglers wird zunächst ein Kommunikationsfehler ausgegeben.

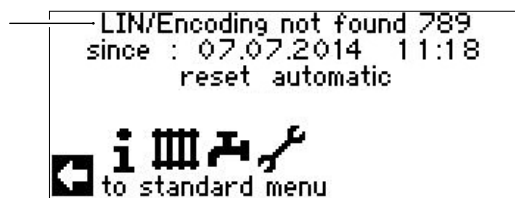

Example of a connection error displayed on the screen.

Beispiel eines im Bildschirm angezeigten Kommunikationsfehlers

The navigation screen is displayed by turning the “rotary push-button”.

If the emergency mode is active, corresponding warning symbols are shown in the standard screen.

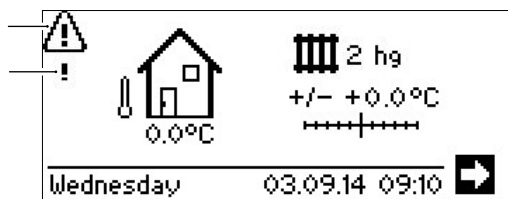

During the emergency mode, the compressor request is locked. To ensure heating operation and domestic hot water preparation, set the “2nd heat gen.” option as the “Heating” operating mode and the “Domestic hot water” operating mode.

### NOTE

The “2nd heat gen.” setting increases the energy consumption.

During the emergency mode, the search for missing system components continues in the background.

If the missing components are detected during the emergency mode, the system is automatically restarted.

### NOTE

The operating modes “Heating” and “Domestic hot water” must be manually reset from the option “2nd heat gen.” to the option “Auto(matic)”.

If the compressor of the heat pump fails during operation, the operating modes “Heating” and “Domestic hot water” can also be set to the option “2nd heat gen.” if required.

This can ensure that heating and domestic hot water are prepared until the cause of the compressor failure has been rectified.



## ❄️ Program area “Cooling”

The “Cooling” function with automatic changeover between heating mode and cooling mode (depending on requirements) can be used with a mixing circuit.

In order to use the cooling function with further mixing circuits, the installation of the expansion board (extra-cost accessory) is required.

The program area “Cooling” must be set by authorised service personnel during commissioning.

Necessary setting:

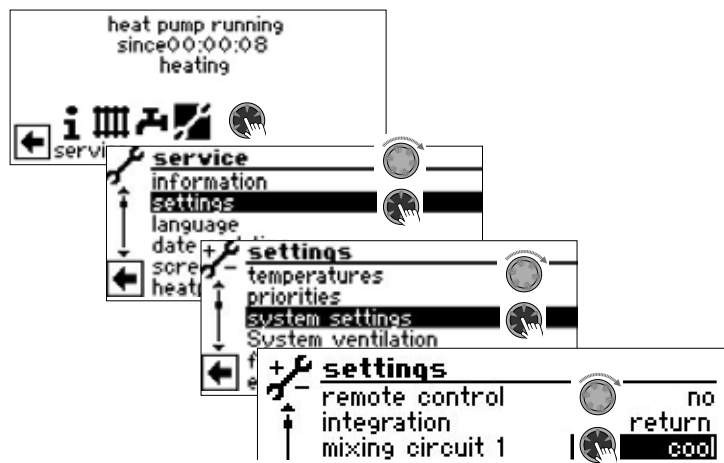

Mixing circ 1 = Cool

→ page 27, “Determining system setting”, “Mixing circ 1”

### ! IMPORTANT

If a cooling circle mixer is connected, it is imperative to activate the function “Cooling”, as otherwise malfunctions will occur in the mixer connected.

### ! IMPORTANT

The use of cooling requires that you integrate a dew point sensor in the system. This must then either be connected in series with the cooling sensor or used instead of the bridge, if cooling is provided via the flow cooler.

### i NOTE

The minimum flow temperature of cooling is factory set to 18 °C. This value can be changed in the menu “Determining temperatures” in the menu item “min. flow cooling”

### ! IMPORTANT

For brine/water heat pumps with integrated hydraulic components, do not set the minimum flow temperature of cooling to < 18 °C.

→ page 24, “Determining temperatures”

If the cooling function is set, the symbol ❄️ for the program area “Cooling” will appear in the navigation screen



## SELECT PROGRAM AREA

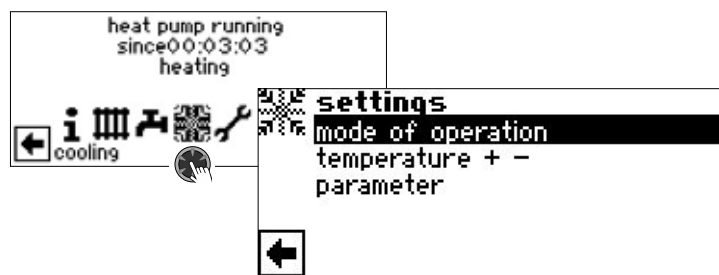

Menu field “mode of operation” leads to the menu “Cooling mode of operation”

Menu field “Temperatur + -” leads to the menu “Cooling Temperature”

Menu field “Parameter” leads to the menu “Cooling Parameter”

## SETTING THE MODE OF OPERATION “COOLING”

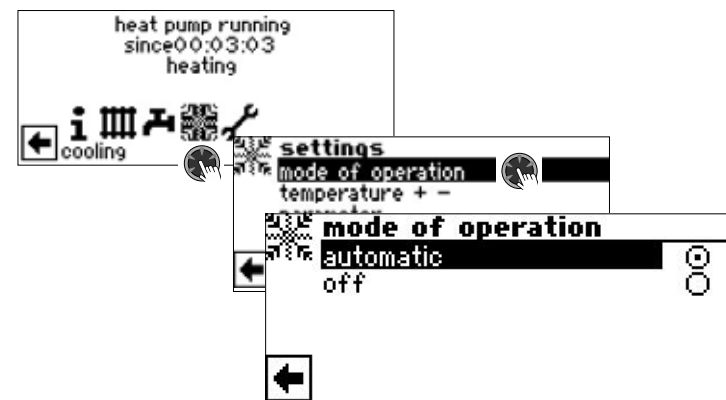

The current mode of operation is highlighted with ●:  
Auto

Switches the cooling function on depending on the outside temperature release or in accordance with a fixed set temperature (= setpoint temperature).

**Off**

Cooling is generally deactivated.

### i NOTE

Cooling is always the lowest priority.

Example: If there is a demand for domestic hot water, the cooling will be interrupted or not released.



**NOTE**

Activate the automatic mode only during the summer months or shut off the cooling during the heating period by means of a room thermostat. Otherwise, it is possible that, depending on the location of the outdoor sensor, the system will switch to cooling if the outdoor temperature exceeds the set temperature.

**NOTE**

Automatic operation also means that during the summer months the system will automatically change over to heating mode or to the operating mode selected in the "Heating" program area as soon as the outside temperature drops below the preset value. In order to ensure that the system does not start to heat during the summer months, the operating mode for the heating can be set to "Off".

→ Part 1 of the controller manual, program area "Heating", section "Setting the operating mode for the heating"

**SET TEMPERATURES**

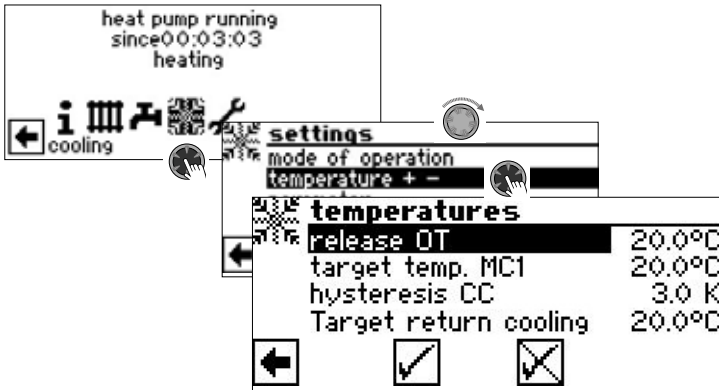

**release OT**  
Required outdoor temperature release  
The cooling is enabled for the duration of the time set under "Parameters" when above the preset value.

→ Set parameter

**target temp. MC1**  
Required set temperature for cooling in mixing circle 1  
The target value determines the control variable for the activated cooling mixer, insofar as the cooling is to be carried out based on a fixed temperature. If cooling enable is set based on the outside temperature (set. AT.), the menu field "OT diff. MC1" appears here. Then enter a corresponding temperature spread in Kelvin.

**hysteresis CC** Hysteresis cooling regulator  
Without an expansion board installed, displayed only for reversible air/water heat pumps and controls the automatic changeover from passive to active cooling

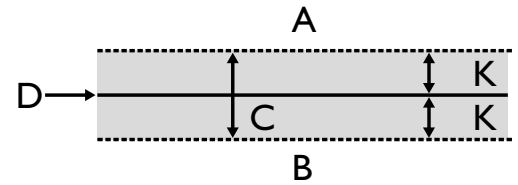

- A There will be a request for active cooling in this temperature range
- B There will be no request for active cooling in this temperature range
- C Neutral zone
- D Set temperature of mixing circuit
- K Hysteresis in Kelvin

target return cooling  
Menu field "Target return cooling" is shown only with some reversible air/water-heatpumps.

**SET PARAMETERS**

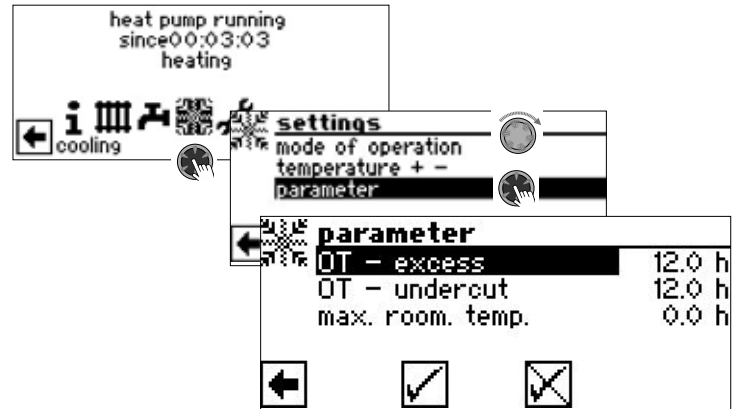

**OT – excess** (maximum outside temperature)  
Cooling starts in the "Automatic" operating mode if the outdoor temperature is exceeded for longer than the time set under "OT – excess" or once by more than 5 K.

**OT – undercut** (minimum outside temperature)  
Cooling is terminated in the "Automatic" operating mode if the outdoor temperature falls below the set time for "OT – undercut" for longer than the outdoor temperature

**max. room. temp.** (maximum room temperature)  
The menu field for regulating the cooling based on room temperature depending on the outside temperature appears only if the system has a room control unit (RBE) and the corresponding settings have been implemented.

→ Operating manual RBE – Room control unit

**NOTE**

For brine/water- and water/water-heat pumps the cooling will only be enabled if the brine inlet temperature is > 2 °C. The set setpoint temperature defines the flow temperature of the heat pump during cooling.

## COOLING BASED ON SET TEMPERATURE OR DEPENDING ON OUTDOOR TEMPERATURE

The cooling can be released based on the outdoor temperature or in accordance with a fixed temperature (= set temperature).

Cooling based on set temperature

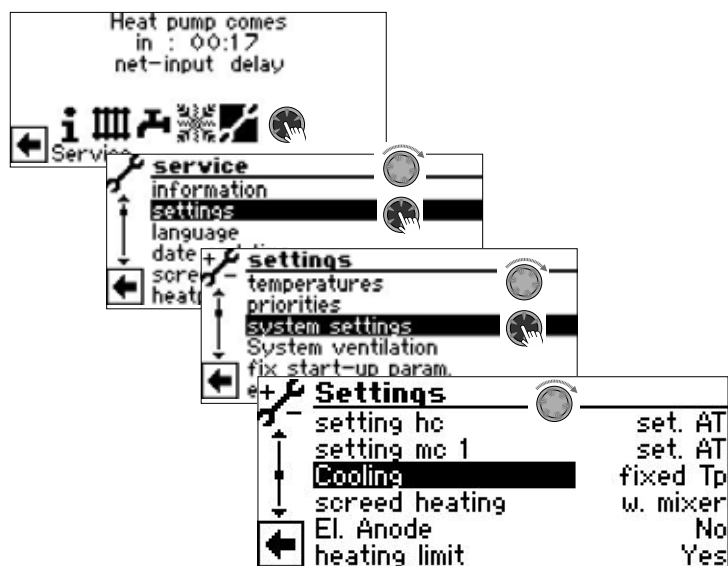

With the “fixed Tp” setting, the supply temperature of the cooling represents the setpoint temperature set for the mixing circuit 1 (MC 1):

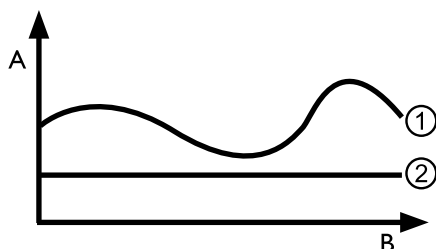

- A Temperature
- B Time
- 1 Outdoor temperature
- 2 fixed Tp (= set temperature mixing circuit)

Cooling depending on outdoor temperature

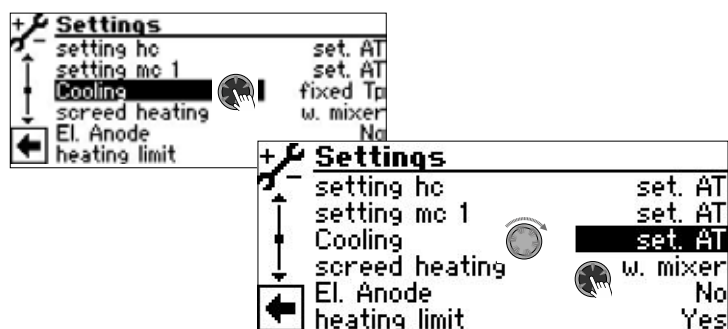

With setting “set. AT” set temperatures are ignored. Instead, set temperatures are automatically calculated based on the outdoor temperature.

The calculation is based on the value entered in Kelvin under “OT diff. MC1” but is restricted to a spread of 1 K – 10 K (adjustable in 0.5 steps).

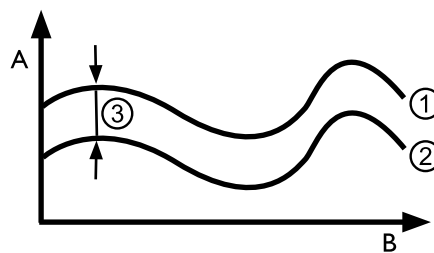

- A Temperature
- B Time
- 1 Outdoor temperature
- 2 Set temperature mixing circuit
- 3 set. AT (= outdoor temperature difference)

## ENABLE ACTIVE COOLING

**NOTE**  
The active cooling function can only be used if the system is utilised in accordance with the corresponding hydraulic diagram. There is otherwise no guarantee that the active cooling with function properly.

**NOTE**  
For brine/water heat pumps, active cooling is only possible if the expansion board (extra-cost accessory) is installed.

**IMPORTANT**  
The use of active cooling is generally excluded for brine/water heat pumps with integrated passive cooling function.

The active cooling function may only be used if the heating and heat pump controls are equipped with software > 3.31.



## Program area "Service"

### NOTE

The software automatically detects the connected heat pump type. Parameters that are not relevant for the conditions of the system and/or the heat pump type are hidden. Some of the parameters documented in this program area may therefore not appear on the screen of your heating and heat pump controller. Many menus require scrolling with the "rotary pushbutton".

### NOTE

Some menu entries and parameters are also only visible or adjustable when installation technician or customer service access is active. The different data access levels are marked in this operating manual by symbols.

→ page 2, "Symbols"

### NOTE

Some parameters have adjustable value ranges. These can be found in the appendix.

→ page 57, "System setting during commissioning"

## SELECT PROGRAM AREA

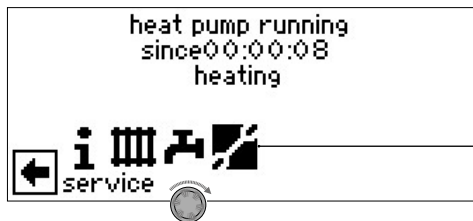
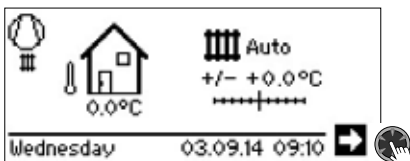

## QUERY INFORMATION



## Query Temperatures

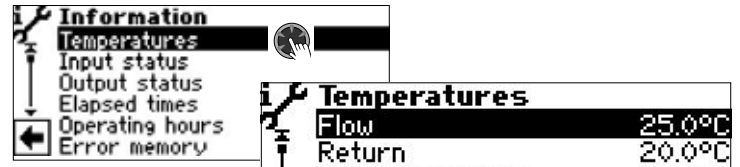

The menu is not shown in full here.

flow	Flow temperature heating circle
target flow temp.	Flow setpoint temperature heating circle
return	Return flow temp. of heating circle
Return target	Return setpoint heating circle
return external	Return temp. in separate tank.
hot gas	Hot gas temperature
outdoor temp.	External temperature
outdoor temp. Ø	Average temperature outside over 24 h(function heating limit)
DHW	Domestic hot water actual temperature
upper DHW	Temperature in the upper part of the domestic hot water tank
DHW target	Domestic hot water target temperature
heat source inlet	Heat source inlet temperature
Heat source out	Heat source outlet temperature
mix circ1 flow	Mixing circle 1
	Forward flow temperature
mix circ1 target	Mixing circle 1
	Forward flow set temperature
Roomstation	Current temperature of the room control unit (RBE)

In addition – depending on the unit type of the connected heat pump – the cooling circuit information provided by sensors in the cooling circuit appears here.

max flow temp.	Maximum flow temperature
suction compressor	Compressor suction temperature
suction evaporator	Evaporator suction temperature
compressor heating	Compressor heating temperature
overheating	Overheating temperature
target overheating	Overheating target temperature
evaporator temp. EVI	Evaporator temperature EVI
suction EVI	Suction temperature EVI
EVI Superheat	Superheating temperature EVI
Target EVI superheat	Superheating target temperature EVI
condensing temp.	Condensing temperature
Liquid temp before EEV	Temperature of the liquid refrigerant upstream of the electronic expansion valve (heating)
evaporating temp.	Evaporation temperature
condensing temp.	Condensation temperature
TFL1	Temperature of the liquid refrigerant upstream of the electronic expansion valve (heating)
TFL2	Temperature of the liquid refrigerant upstream of the electronic expansion valve (cooling)
subcooling EEV	Calculated subcooling at the electronic expansion valve
Hot gas limit	Maximum hot gas temperature
Defrost End	Target temperature in the evaporator to end defrosting
desuperheater	Temperature at the desuperheater



Switch box	Temperature in the electrical switch box
DSH	Hot gas overheating temperature
DSH target	Hot gas overheating target temperature

### Query inputs

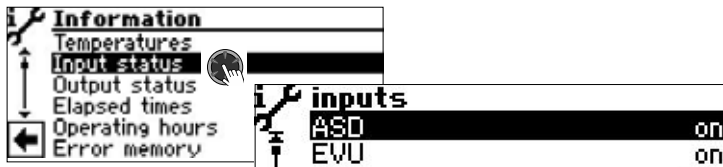

The menu is not shown in full here.

**NOTE**  
This menu shows whether the digital inputs of the controller are switched on or off.

ASD	Defrost, Brine pressure, flow Depending on the device type, the input can fulfil various functions: For <i>L/W-devices</i> Defrost end pressostat: On = Defrost is terminated. For <i>LWP, S/W and W/W devices</i> with flow switch connected at the factory: On = Flow okay. For <i>S/W-devices</i> without flow switch connected at the factory, a brine pressostat can be connected: On = brine pressure sufficient.
SW-therm. switch	Domestic hot water thermostat On = Domestic hot water requirement
EVU	Off-time of the electrical supplier Off = Off-time
HD	High-pressure pressostat Off = Pressure okay
MOT	Motor protection On = Motor protection okay.
ND	Low pressure pressostat On = Pressure okay.
potent. ext.	Connection of an external current anode (possible for some devices)
Analog In ...	Analogue input signal (e.g. for flow sensor)
release cooling	ON = cooling enabled (from external) present
HD	High-pressure sensor
ND	Low-pressure sensor
flow rate	Heating circuit flow rate
smart grid	1 EVU blocking time 2 decreased operating mode 3 normal operating mode 4 increased operating mode → page 37, "Operating states"
EVU 2	Additional energy supplier (EVU) signal for displaying the Smart Grid states
STB immersion heater	Safety temperature limiter (STB) for monitoring the electric heating element ON = STB OK OFF = STB has triggered

EVI pressure	Pressure, EVI pressure sensor
Inverter voltage	Mains voltage from the energy supplier (EVU)
COPS	on = Accessory COPS is activated

### Query outputs



The menu is not shown in full here.

Defrost demand	Defrost request
dv-defrost valve	Valve / Circuit reversal ON = Thaw mode or rather cycle reversal becomes active
BUP	Domestic hot water circulation pump
FP 1	Floor heating circulation pump
HUP	Heating circulation pump
MA1	Mixer 1 opens On = opens / Off = no control
MZ1	Mixer 1 Close On = closes / Off = no control
Ventilation	Ventilation of the heat pump housing for certain L/W devices. For L/W size types (coding "L2G"), second stage of the ventilator
VBO	Ventilator, well or brine circulation pump
Compressor	Compressor(s) in heat pump
Compressor 1	Compressor 1 in heat pump
Compressor 2	Compressor 2 in heat pump
ZIP	Circulation pump
ZUP	Additional circulating pump
ZWE 1	Additional heating generator 1
ZWE 2	Additional heating generator 2 – Collective fault (function collective fault: Continuous ON in the event of a fault, cycles 1x per second with automatic RESET enabled)
AO ...	Analogue output ... (power supply e.g. for flow sensor)
compressor heating	Compressor heating
HUP	Heating circulating pump power in %
ZUP	Additional circulating pump power in %
freq. targ.value	Target compressor speed
freq. current	Current compressor speed
freq. min.	Minimum compressor speed
freq. max.	Maximum compressor speed
control signal CP	Circulation pump output in %
rotation speed fan	Current speed of the heat pump's fan
rotation speed VD	Current speed of the heat pump' compressor
EVi opening	Enhanced vapour injection, opening
EEV opening	Electronic expansion valve, opening
EEV heating	Electronic expansion valve, heating
EEV cooling	Electronic expansion valve, cooling
VBO targ. value	Setpoint brine circulation pump
VBO current	Current value brine circulation pump
HUP targ. value	Setpoint heating circulating pump





HUP current	Current value heating circulating pump
ZUP targ. value	Setpoint additional circulating pump
ZUP current	Current value additional circulating pump

### Query elapsed times



The menu is not shown in full here.

HP since	Heat pump running since (Time indication respectively in hh:mm:ss)
ZWE1 since	Additional heating generator 1 running since
ZWE2 since	Additional heating generator 2 running since
net-input delay	Net input delay
SCB time	Off-time switching cycle
VD off since	Compressor downtime
hc add-time	Heating control more time
hc less-time	Heating time less time
TDI since	Thermal disinfection running since
blockade DHW release ZWE Heat.	Off-time domestic hot water Duration of the release of the additional heating generator in heating mode
release ZWE DHW	Duration of the release of the additional heating generator during domestic hot water preparation
release cooling	Duration of the release of the cooling
Defrosting	Time until the next defrosting
block 2.VD HG	Disabling of 2nd compressor in the event of hot gas exceedance

### Query operating hours



The menu is not shown in full here.

operating hours VD1	Operation hours compressor 1
Impulse VD1	Impulses compressor 1
running time Ø VD1	average duration compressor 1
operating hours VD2	Operation hours compressor 2
Impulse VD2	Impulses compressor 2
running time Ø VD2	average duration compressor 2
operating hours ZWE1	Operation hours additional heating generator 1
operating hours ZWE2	Operation hours additional heating generator 2
operation hours HP	Operation hours Heat pump
operat. hours heat	Operation hours Heating
operation hours DHW	Operation hours domestic hot water
operat. hours cool	Operation hours Cooling

**NOTE**  
The compressors are only energised alternately following the impulses. A variation in the operation hours of the compressors is, therefore, possible.

### Query error memory

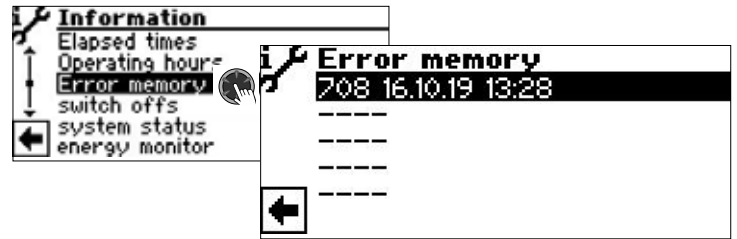

728  
Error number (here by way of example)  
16.10.19  
Date of the resulting error (here by way of example)  
13:28  
Time of the error that occurred

If an entry is clicked, the corresponding information for this entry is displayed.

→ Meaning of the error numbers: page 50

**NOTE**  
Maximum the last five resulting errors are displayed.

### Query switch offs

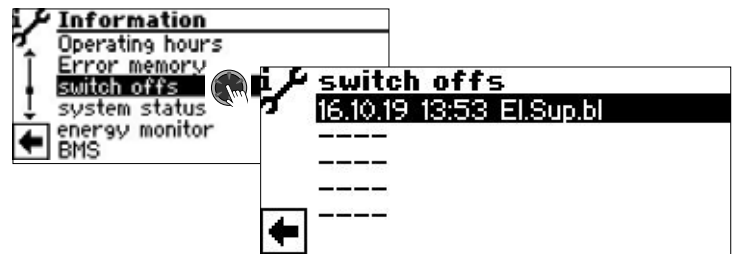

16.10.19  
Date of the disconnection (here by way of example)  
13:53  
Time of the disconnection (here by way of example)  
El. Sup. bl  
Disconnection code (here by way of example)

err. HP	heat pump fault
err. inst.	system fault
OM ZWE	mode of operation additional heating generator
EVU-block	el. sup. blockade
Defr. air.	air defrost
TPLmax	temperature limits maximum of application
TPLmin	temperature limits minimum of application
low lim	lower limit of application
no requ.	no request
TEE	External energy source
flow	Flow
p0_break	Low pressure pause
u0_break	Superheating pause





I0_break	Inverter pause
DSH_break	Overheating hot gas pause
h0_break	Hot gas pause
D0_break	Desuperheater pause
OpMode	Operating mode for switching over
Stop	Other shutdown

**NOTE**  
Maximum the last five disconnections are displayed.

If an entry is clicked, the corresponding information for this entry is displayed.

### Query the system status

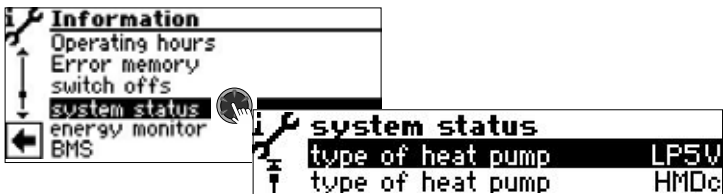

The menu is not shown in full here.

Type of heat pump	Type of heat pump
Type of heat pump	Type of hydraulic unit
Hydrauliccode	With data access "Installer" or "Service", the hydraulic code can be changed by clicking on the menu line of the heating and heat pump control
Software version	Prozessor version
Revision	HZ/IO version
HZ/IO	Software version ASB
ASB	Hardware revision ASB
ASB HW Revision	Software version inverter
Inverter SW Version	Hardware type inverter
Inverter HW Type	Bivalence level:
bivalence level	1 = a compressor may operate
	2 = two compressors may operate
	3 = additional heating generator may operate as well
operation mode	Current operation mode:
	Heating, DHW, ...
	Defrost, El.Sup.bl., ...
Heating capacity	Heating output currently provided by the output-controlled compressor. This heating output can be used to set the overflow valve in a storage tank integrated in series according to the setting diagram in the unit instructions.
Target heat capacity	Required output for output-controlled compressor controlled by the heating and heat pump controller.
Software version SEC	Software version of the inverter controller of the output-controlled heat pump
output max. SEC	Maximum performance SEC
Software version RBE	Software version of the room control unit (RBE)
defrost demand	Defrosting requirement in %
last defrost	Time of last defrost
Stop ID	Compressor switch off identification number

HG Level Excess	Exceeding of the hot gas temperature
overheating mode	SSH = overheating suction gas
	DSH = overheating hot gas

### Query energy monitor

The energy monitor can be used to compare the heat quantity and energy input of operating periods in order to keep an eye on the energy efficiency of the system. If, for example, the operating period of one month shows a significantly higher electricity consumption than the operating periods of the corresponding months of the previous years, it is possible that settings were made on the heating and heat pump control in the meantime that have an unfavourable effect on the energy efficiency of the system. If there are noticeable deviations, the settings on the heating and heat pump control should be checked and corrected if necessary. In addition, the system components should be checked for proper functioning.

The energy monitor is not a calibrated measuring instrument. Therefore, the data provided by it may not be used for billing tenants or for similar purposes. The data provided by the energy monitor is also not suitable for determining the exact seasonal performance factor.

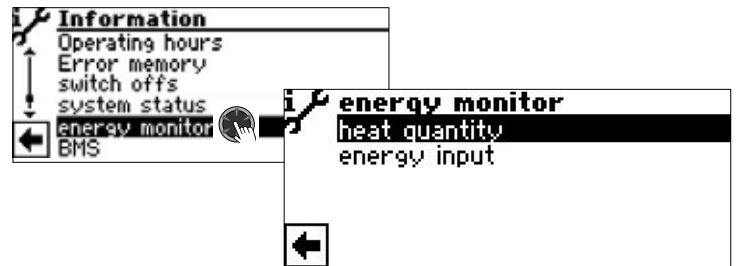

Heat quantity	Thermal energy in kW/h delivered by the system
energy input	Electrical energy in kW/h supplied to the system

### Query heat quantity



total	Thermal energy delivered since installation of the currently installed control unit
current month	Thermal energy delivered in the current month. The values in kW/h displayed in the submenus are updated every 2 hours. After the end of the current month, this month is automatically taken over into the history
history	Thermal energy delivered in previous years and months



**NOTE**

The recorded data are stored on the control unit's circuit board. It is recommended to export the history regularly, as the previously recorded data will be lost in case of a defect / replacement of the control unit.

→ page 22, "Query the history and exporting the history"

**NOTE**

The title (1) of the submenu indicates which operating period is currently being queried. If no year or month appears in the title, the data displayed refers to all operating periods since the installation of the currently installed control unit.

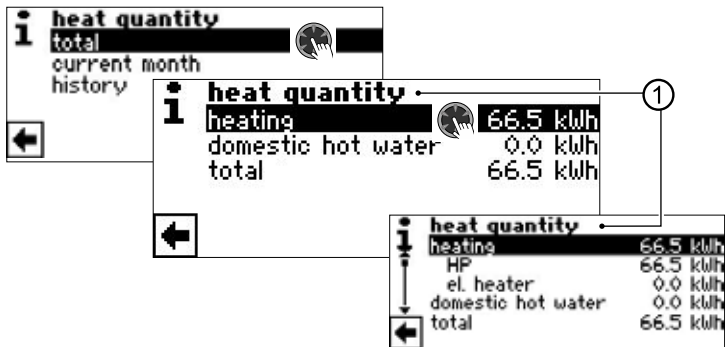

- heating Thermal energy in kW/h delivered for the operating mode heating
- domestic hot water Thermal energy in kW/h delivered for the operating domestic hot water
- total Thermal energy in kW/h delivered for all operating modes

If an entry is clicked, the energy share of the heat pump compressor (HP) and the energy share of the electric heating element (E. heater) are displayed.

**NOTE**

Depending on the system configuration, menu lines also appear for the operating modes cooling and / or swimming pool. If the operating mode cooling and / or swimming pool was initially activated in the current month but later deactivated again, this operating mode no longer appears as a menu line in the menu. However, the energy consumption of this operating mode is still included under "total". In order for menu lines "cooling" and / or "swimming pool" to remain in the menu, it is recommended not to change the system configuration, but only to set the corresponding operating mode to "off".

Query energy input

The query of the data on the energy input is carried out in the same way as the query of the data on the heat quantity described here.

Query the history and exporting the history

The data recorded in previous years and months for all operating periods can be saved as a csv file on a USB stick. The data stored on the control unit's circuit board is retained.



Query building services management system (BMS)

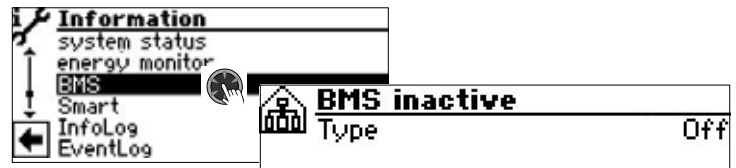

The menu is not shown in full here.

**NOTE**

Data is only displayed if the heat pump is integrated into a building management system. This requires a special configuration of the heating and heat pump controller with additional software that is subject to a charge.

→ Operating manual "Connection to a building services management system via BACnet/IP | ModBus/TCP"



## Query Smart

### **NOTE**

Menu entry is only displayed if customer service access is activated and if:

- Menu entry "room stat." is set to "Smart"
- "Smart" settings have been made.

→ page 27, "Determining system setting", "room stat."

→ page 36, "Smart"

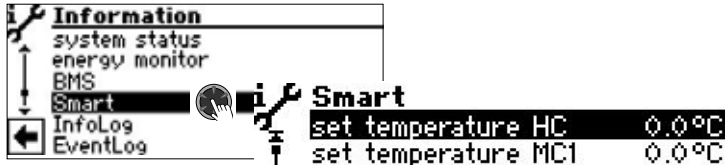

The menu is not shown in full here.

target temp. HC	Setpoint temperature heating circuit
target temp. MC1	Setpoint temperature mixing circuit 1
DHW target	Set point temperature domestic hot water preparation
target value max	Highest requirement setpoint from the Smart system
UFH total HC	Number of floor heating circuits assigned to the heating circuit
UFH open HC	Number of open floor heating circuits assigned to the heating circuit
numb.actuat. HC	Number of radiator drives assigned to the heating circuit
current room temp. HC	Current room temperature of the worst room in the heating circuit
desired room temp. HC	Target temperature of the worst room in the heating circuit
UFH total MC1	Number of floor heating circuits assigned to the mixing circuit 1
UFH open MC1	Number of open floor heating circuits assigned to the mixing circuit 1
numb.actuat. MC1	Number of radiator drives assigned to the mixing circuit 1
current room temp. MC1	Current room temperature of the worst room in the mixing circuit 1
desired room temp. MC1	Target temperature of the worst room in the mixing circuit 1

## Query InfoLog

### **NOTE**

Menu entry is only displayed if customer service access is activated.

Errors that occur during operation of the heat pump are stored in a list in the InfoLog. Each error is timestamped.

The error list contains a maximum of 100 entries. The last error that occurred is at the top of the list. If there are more than 100 entries, the oldest (= last) entry in the list is overwritten.



The menu is not shown in full here.

## Query Inverter

### **NOTE**

Menu entry is only displayed if customer service access is activated. The list displayed on the screen is for service purposes only.

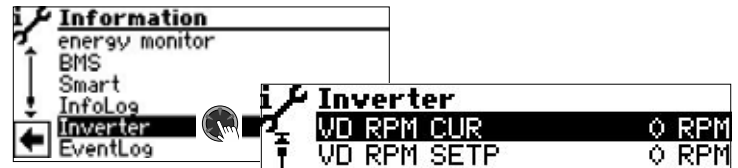

The menu is not shown in full here.

## Query EventLog

### **NOTE**

Menu entry is only displayed if customer service access is activated.

Events that occur during operation of the heat pump and the heating and heating and heat pump controller (e.g. change of system settings) are logged in the EventLog.



The menu is not shown in full here.

If an entry is clicked, detailed information about this event is displayed.

The event list displayed on the screen contains a maximum of 20 entries. The last event that occurred is at the top of the list. If there are more than 20 entries, the oldest (= last) entry is dropped from the list. However, it is not overwritten, but remains stored in the database file behind it. This file can be read out via the "data logger".

→ Part 1 of the controller manual, program area "Service", section "Data logger".



## MAKING SETTINGS

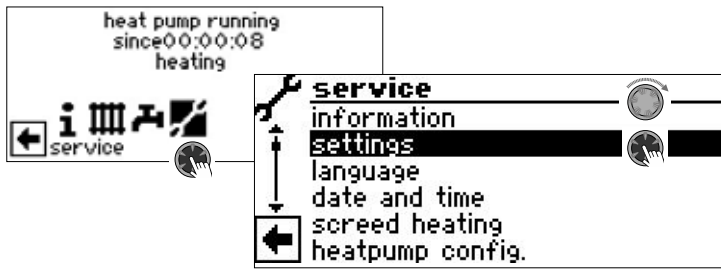

### Determine data access

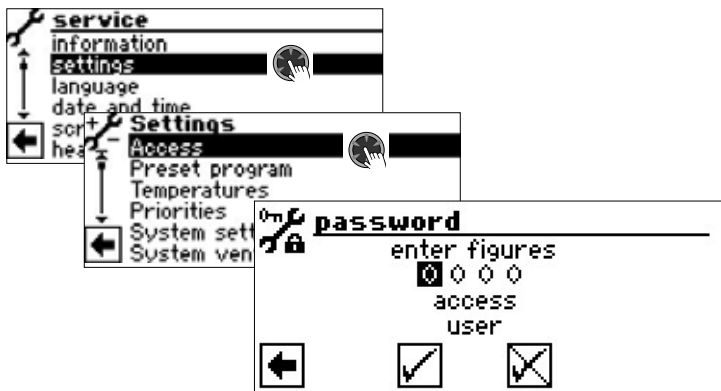

Enter numbersn entry fields of the four digits numerical code (9445 = Access: Installer):

Activate the first entry field of the numerical code by pressing the “turn-push button”. Set the first digit by turning the “turn-push button” and confirm the entry by pressing the button.

Move to the respective next entry field and repeat the steps described above.

Finally, move to  and save the entries by pressing the “turn-push button”.

The entry fields are automatically set to 0000. The cursor goes automatically to the navigation arrow. The program provides information in the menu line “Access” on the selected status of the data access.

Data access  
Information on the current status of the data access (here: user)

### ! IMPORTANT

Incorrect program settings that are not aligned to the system components can cause malfunctions or even serious damage to the system. Therefore, access to basic settings of the system via the installer password 9445 may only be carried out by qualified technicians and must be blocked for unauthorised persons.

After service work, it is essential to reset the data access to “User” (enter and save number code 0000).

### i NOTE

The manufacturer is not liable for damage resulting from wrong program settings not oriented towards the system components.

If the “rotary pushbutton” has not been used for 3 hours, data access is automatically reset to “User”.

## Calling up preset program

→ Part 1 of the controller manual, program area “Service”, section “Calling up preset program”.

## Determining temperatures

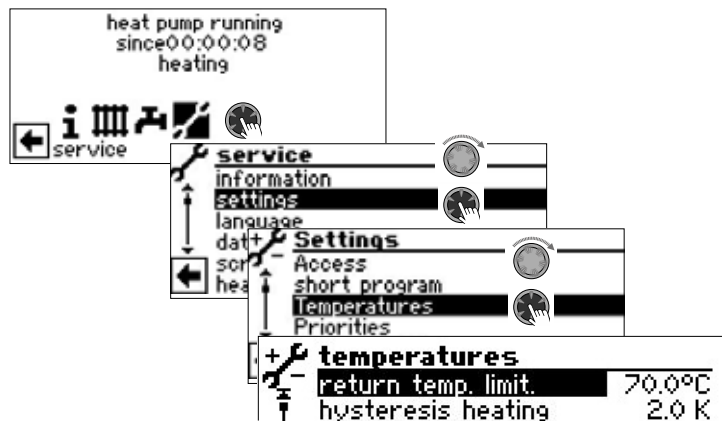

The menu is not shown in full here.

return temp. limit. Return temperature limit  
Setting the maximum return setpoint temperatures in heating mode.

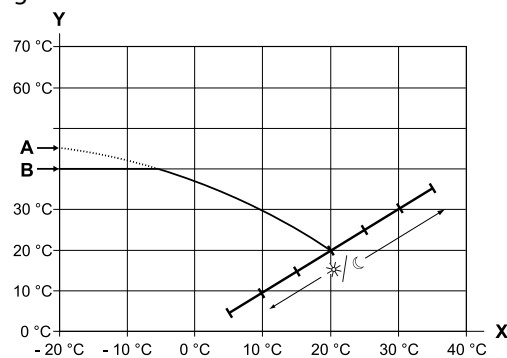

- X External temperature
- Y Return temperature
- A Heating curve-end point
- B Return limit (in the example shown: 40 °C)

hysteresis heating setting for the control hysteresis of the heating regulator

Set a greater hysteresis for very reactive heating systems, and a lower hysteresis for less reactive heating systems.

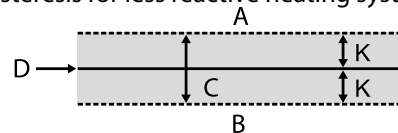

- A There will be no request for heating in this temperature range
- B There will be a request for heating in this temperature range
- C Neutral zone
- D Return setpoint temperature
- K Hysteresis in Kelvin



**hysteresis DHW** Hysteresis of domestic hot water  
Setting for the control hysteresis for the domestic hot water preparation (negative hysteresis).

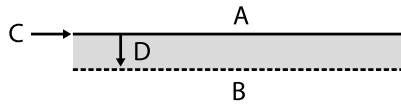

- A There will be no request for domestic hot water preparation in this temperature range
- B There will be a request for domestic hot water preparation in this temperature range
- C Domestic hot water target
- D negative hysteresis

**max. return increase** Return increase maximum  
Setting for the maximum permissible overshoots of the return temperature. If the return temperature is overshoot, internal minimum running times are ignored and all heat generators switched off. Always set value higher than the value of the hysteresis HR.

**Release 2.VD** Release 2nd compresso  
A value is only displayed for devices with two compressors. Setting of the minimum external temperature from which the second compressor can be released in heating mode. Above the set external temperature, the second compressor remains locked in heating mode

**Release ZWE** Release additional heating generator  
Setting for the external temperature from which the additional heating generator can be released if required. Above the set external temperature, the additional heating generators remain locked.  
Exception:  
In the event of a fault and the setting fault with a 2 hg, the additional heating generators are released independently of the set external temperature.

**temp. air defrost** Temperature air defrost  
Setting for the release temperature for the air defrost. Below the set temperature, the air defrosting is locked.

**! IMPORTANT**

Set air defrost only if device type is approved for air defrost.

**TDI target temp.** TDI setpoint temperature  
Setting for the setpoint temperature for the thermal disinfection in the domestic hot water preparation.

**Flow temp. 2VD DHW** Flow 2nd compressor Domestic hot water  
Setting for the flow temperature up to which domestic hot water is prepared with the second compressor. Optimisation of the charging time and the attainable domestic hot water temperatures.

**max. outdoor temp.** maximum external temperature  
Setting for the maximum external temperature from which the heat pump is locked.  
Additional heating generators are released as required.

**min. outdoor temp.** minimum external temperature  
Setting for the minimum external temperature under which the heat pump is locked.  
Additional heating generators are released as required.

**min. heat source temp.** Minimum heat source temperature  
Setting for the minimum permissible temperature at the heat source outflow of the heat pump .

for S/W devices:  
With AS access, a value above -9 °C can be set (necessary for integration with intermediate exchangers)

for W/W devices  
The setting is only available with manufacturer access.

**min HS in flow max** Minimum heat source inlet temperature at maximum supply flow rate

**max. hot gas temp.** Maximum hot gas temperature  
Setting for the maximum permissible temperature in the cooling circle of the heat pump.

**temp.air defrost stop** Temperature air defrost end  
A value is only displayed for L/W devices and if the air defrost is switched on.  
Setting for the temperature at which the air defrosting is terminated at the outlet of the evaporator.

→ page 56, "Overview: Defrost cycle, Air defrost, Flow Max"

**lowering to** Maximum lowering  
Setting for the external temperature up to which a night lowering is carried out.  
If the actual external temperature falls below the set value, the lowering temperature is ignored.

**max. flow temp.** Maximum flow temperature  
If this temperature is exceeded in the flow, a compressor of the heat pump is switched off. This applies to all supply types!

→ page 56, "Overview: Defrost cycle, Air defrost, Flow Max"

**min. OT flow max.** Heat source temperature-dependent adjustment of the flow temperature.  
The outside temperature, up to which the flow max. temperature with the heat pump may be increased, is adjusted here.  
Below this outside temperature, the actual VL maximum temperature of the heat pump will fall linearly to the value "low limit of applic."

**flow operation limit** Heat source temperature-dependent adjustment of the flow temperature.  
Here, the maximum forward flow temperature of the heat pump is set at an outside temperature of -20°C.  
For further details, see point "min. AT flow max." and the following diagrams:

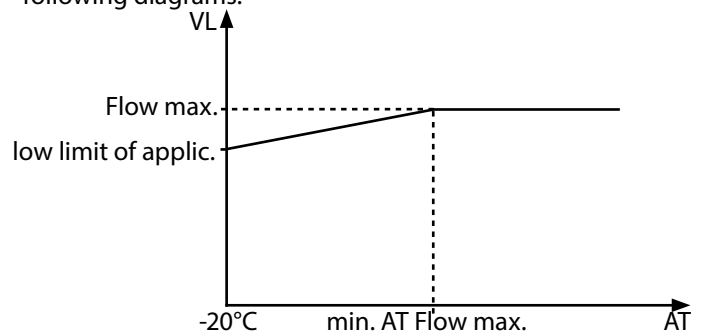





hysteresis CC Hysteresis cooling circuit  
Standard value for reversible air/water heat pumps: 3 K  
Standard value for brine/water heat pumps: 2 K

DHW temp. max. Maximum domestic hot water temperature  
A value, which is set to limit the maximum set temperature of the domestic hot water.

min return targ.temp Minimum return set-point temperature  
Will not be exceeded in operation.

Defrost end temp. Defrost end temperature

minimal flow mc 1 Minimum flow temperature mixing circuit 1  
Will not be exceeded in operation.

maximum flow mc 1 Maximum flow temperature after the mixer mc 1  
Will only be displayed if mixing circuit 2 is set to "Discharge" or "heat+cool". Then the supply sensor on TB2 serves to restrict the supply temperature in accordance with the mixer. This means that if TB2 exceeds the value set here, the mixer is driven in the "closed" direction.

reduct. 2 VD hyster. Hysteresis heating control 2nd compr.  
Shorten HR hysteresis. HR. Hysteresis heating regulator from which the cut-in time of the 2nd. compressor stage is shortened (See "System setting").  
Cutting-in compressor 2:

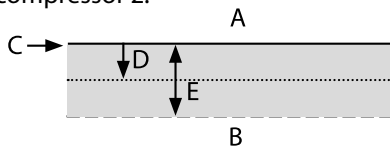

- A No cut-in
- B Shortened cut-in
- C Return flow set value
- D Heat regulator hysteresis
- E Hysteresis HR shortened

desuperheater max. Maximal temperatur desuperheater  
min. flow cooling Minimum flow temperature cooling  
If the temperature at the cooling sensor falls below this temperature (depending on integration TB1, TB2 or TRL), the cooling is interrupted (factory setting 18°C). At the same time, the displayed value is the minimum limit value for settable cooling setpoint temperatures.

min. flow cooling 2VD Minimum flow temperature cooling 2nd compressor  
If the temperature at the cooling sensor falls below this temperature (depending on integration TB1, TB2 or TRL), the cooling is interrupted (factory setting 18°C). At the same time, the displayed value is the minimum limit value for settable cooling setpoint temperatures.

night lowering HC Temperature by which the heating is lowered in night mode compared to day mode

night lowering MC1 Temperature by which the mixing circuit 1 is lowered in night mode compared to day mode

Scroll all the way down, cancel or save the settings.







## Hot gas utilisation / desuperheater

(only LWP)

Higher temperatures of up to 75°C are available with hot gas utilisation. The temperature is not always guaranteed. The heat pump must already be in operation due to another requirement.

The heat pump will switch off with a desuperheater temperature of 80°C.

The recirculation pump will be actuated every 30 minutes for 30 seconds with a hot gas temperature higher than 85°C



### CAUTION

**Injuries caused by hot temperatures!**

Very high temperatures can occur on the desuperheater and the pipework for the hot gas utilisation when the hot gas utilisation is in operation. Any contact can lead to burns. Never touch the desuperheater or pipework when in operation or afterwards

The hot gas utilisation is set to "Yes" as default.

If the desuperheater is selected in the FlexConfig menu (→ page 35, "FlexConfig"), the temperature can be stipulated.

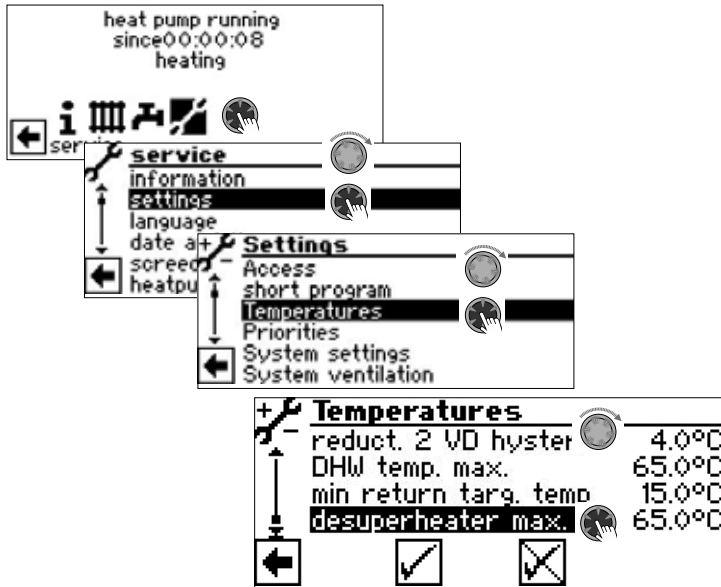

Here you can fix the temperature of the desuperheater from 30°C to 75°C.

If no hot gas is to be used, the desuperheater must be deselected in the FlexConfig menu.

## Determining priorities

→ Part 1 of the controller manual, program area "Service", section "Determining priorities".

## Determining system setting

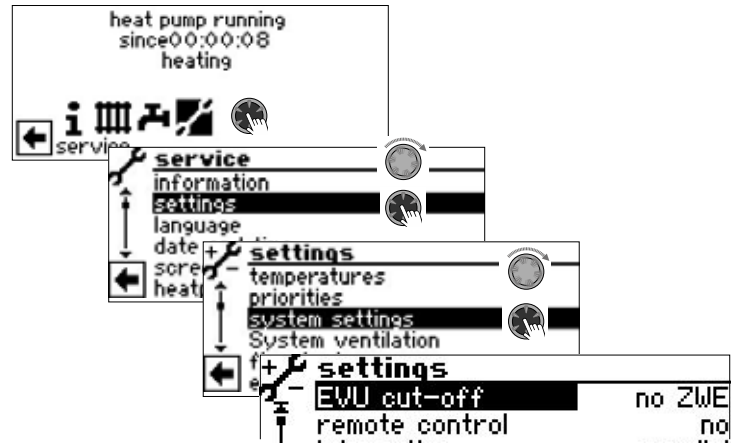

The menu is not shown in full here.

### ! IMPORTANT

Incorrect settings not oriented towards the system components put the safety and functional capability of the system at risk and can lead to damage.

### i NOTE

Enter deviations from the relevant factory settings in the overview "System setting during commissioning".

→ page 57, "System setting during commissioning"

EVU cut-off	no ZWE	Electrical supply off-times 2hg at electrical supply off-time also locked
	with ZWE	2hg released for electrical supply Setting only takes effect as 2 hg for boiler or thermal.
remote control	No	Roomstation No roomstation connected
	RBE	RBE room control unit (purchasable accessories) connected
	Smart	Smart-individual room control (purchasable accessories) connected
Integration	series	Hydraulic Integration Setting the hydraulic integration of the buffer tank hydraulic integration with row tank (flow/return)
	parallel	hydraulic integration with parallel tank (multifunction tank)

### i NOTE

External return flow sensor (TRLeXT) required for "Sep. tank" setting.



## Mixing circuit 1

Setting the functioning of the mixer control  
*charge*

## Mixing circuit 1

Do **not set** for output controlled heatpumps.  
Mixer serves as charger mixer, possibly for a boiler

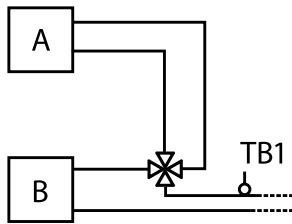

A Boiler  
B Heat pump  
TB1 sensor flow

*discharge*

Mixer serves as a control mixer, possibly for floor heating

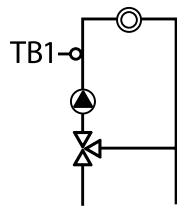

*cool*

TB1 sensor flow (mandatory)  
Activation of the cooling function  
If a mixer is present, it then serves as a control mixer for the cooling function

*heat+cool*

Activation of the cooling function (with parallel mode only with the master heat pump possible)  
If a mixer is present, it then serves as a control mixer for the heating and cooling function

*no*

Mixer without function

### **NOTE**

Cooling is controlled via TB1 sensor (via TVL sensor with bridged TB1 contact) for **integration of "Return"** or via **TRLext** sensor for **integration of "Sep.tank"**.

## Error

*no ZWE*

Error in the event of a fault in the heat pump, connected ZWE are only energised if the return temperature < 15 °C (antifreeze); (only heating)

Heating  
DHW  
*with ZWE*

Domestic hot water in the event of a fault in the heat pump, connected ZWE are energised according to requirements (HW + DHW)

## DHW 1

*Sensor*

## Domestic Hot Water 1

Domestic hot water preparation is initiated or terminated via a sensor with hysteresis (factory setting: 2K) in the domestic hot water tank.  
Domestic hot water preparation is initiated or terminated via a thermostat on the domestic hot water tank.  
No temperatures can be set in the controller

*Thermostat*

### **NOTE**

Connect domestic hot water thermostat on the same terminals as the domestic hot water sensor (low voltage). The domestic hot water thermostat must be suitable for low voltage (floating contact).  
Thermostat closed (= signal On) = Domestic hot water requirement.

## DHW 2

*ZIP*

## Domestic Hot Water 2

Setting ZIP means circulation pump.

→ For the corresponding settings, please refer to the description of the circulation pump in the operating manual part 1, program section "Domestic hot water", section "Circulation".

*BLP*

Setting BLP means that the ZIP output will be active during domestic hot water preparation and switch off 30 seconds after domestic hot water preparation is complete.

### **NOTE**

If the "DHW 2" menu field is not visible, you must make this setting in the "FlexConfig" menu under "OUT 2".

→ page 35, "FlexConfig"

## DHW 3

*with ZUP*

## Domestic Hot Water 3

Additional circulation pump runs during domestic hot water preparation  
Additional circulation pump does not run during domestic hot water preparation

*no ZUP*

## DHW 4

*targ.value*

## Domestic Hot Water 4

Heat pump attempts to reach the set setpoint value of the domestic hot water temperature

## DHW 5

*with HUP*

## Domestic Hot Water 5

Heating circulation pump runs always during domestic hot water preparation  
Heating circulation pump does not run during domestic hot water preparation  
Heating circulation pump runs parallel to domestic hot water preparation if a heating demand exists. If the heating limit is exceeded, the heating circulation pump switches off.

*no HUP*

*par. HUP*



DHW+HP max Maximum running time domestic hot water preparation + Heat pump  
After the set time has expired, the 2nd heat generator in the domestic hot water preparation energises, but only if this has been released previously in the heating mode!

Defrost cycle max Defrost cycle time, maximum time between two defrost processes  
You can find the time to be set for the relevant L/W device in the operating manual. If you do not find any data there, the following applies:

→ page 56, "Overview: Defrost cycle, Air defrost, Flow Max"

air defrost Air defrost  
No Air defrost not released  
Yes Air defrost generally released above the set temperature

→ Approved appliances, see page 56, "Overview: Defrost cycle, Air defrost, Flow Max"

### ! IMPORTANT

Do not set an "air defrost" on non-approved appliances.

air defrost max Maximum duration of air defrost  
Option only possible if air defrost enabled

pump optimization Pump optimization  
No Heating circulation pumps always run, unless another supply type is requested (domestic hot water, ...) or the device is switched off  
Yes Setting only effective with an outdoor temperature > 0 °C.

Heating circulation pumps are switched off, if required  
The heating circulation pumps will be switched if the heat pump has not been requested for more than 3 hours. The heating circulation pumps will then cycle for 5 minutes every 30 minutes until the heat pump receives another request.  
If the external temperature is above the return setpoint temperature, the heating circulation pumps will be switched off permanently. They will be switched on for 1 minute every 150 hours to prevent them from becoming stuck

### ! IMPORTANT

In the case of multi-function domestic hot water tank integration with solid or solar systems, pump optimisation must be set to "No".

access Data access authorisation

If "installer" is selected, all parameters that can otherwise only be viewed and changed with "AS" access (= customer service with USB stick) can be viewed and changed with the installer password.

brine pres/flow Brine pressure / flow  
No neither brine pressure pressostat nor flow switch connected  
*brine pres.* for S/W devices, a brine pressure pressostat is connected on the Defr/Brin/Flow input  
*flow rate* for W/W devices, a flow switch is connected on the Defr/Brin/Flow input  
*pow.suppl.* Phase monitoring relay installed in the supply pipe of the compressor is connected on Defr/Brin/Flow input  
*pow.+ flow* Phase monitoring relay and flow switch are connected on the Defr/Brin/Flow input

### ! IMPORTANT

For certain devices, a flow switch is installed at the factory. In this case, always set Defr/Brin/Flow to "pow. Suppl." or "pow.+ flow".

An incorrect setting will compromise the safety and functional capacity of your device and can result in serious damage.

monitoring VD Compressor monitoring  
*Off* Compressor monitoring switched off  
*On* Compressor monitoring switched on, if the rotating field of the supply line is incorrect, a "Net On" fault will be detected

→ page 51, Error number 729

While the compressor is starting up, compressor monitoring checks the change in temperature in the hot gas. If the temperature of the hot gas does not change while the compressor is running, a malfunction is displayed.

### ! IMPORTANT

Only switch on compression monitoring for error locating during maintenance work.

In the case of devices with a power supply monitor, the compressor monitoring is switched off in the factory setting.

control HC Control of the heating circle  
*OT regul.* flow setpoint temperature of the heating is calculated via a set heating curve  
*fix temp.* flow setpoint temperature can be selected independently of the external temperature specification

control MC1 Control of mixing circle 1  
*OT regul.* return setpoint temperature of the heating is calculated via a set heating curve  
*fix temp.* return flow setpoint temperature can be selected independently of the external temperature specification

cooling Cooling control  
*OT regul.* Cooling depends on the outdoor temperature  
*fix temp.* Cooling takes place per set temperature

→ page 17, "Cooling based on set temperature or depending on outdoor temperature"



<p>screed heating </p> <p>Option only possible for external energy source (wood boiler, solar system with parallel tank, ...)) <i>with mixer</i></p> <p><i>no mixer</i></p>	<p>Mixer behaviour during the screed heating program</p> <p>If the mixer is defined as a discharge mixer, it controls according to the setpoint temperature in the screed heating program</p> <p>If the mixer is defined as a discharge mixer, it always starts up during the screed heating program</p>
<p>electrical anode </p> <p>Impressed current anode in the domestic hot water tank</p> <p>Yes</p> <p>No</p>	<p>Electrical anode</p> <p>Impressed current anode present</p> <p>Impressed current anode not present</p>

**! IMPORTANT**

In the case of devices with an impressed current anode tank, "Yes" must be set in this menu field in order to ensure the corrosion protection of the tank.  
The impressed current anode must be connected according to the operating manual of the relevant heat pump.

<p>heating limit </p> <p>Yes</p> <p>No</p> <p>If the heating limit parameter is set to yes, the heating will automatically be switched off to summer mode and vice versa.</p> <p>If the heating limit is enabled, the daily mean temperature will be displayed under Service &gt; Informations &gt; Temperatures. At the same time, the heating menu will contain the menu item heating limit. You can use this menu item to set the temperature from which the heat pump is not supposed to provide any more heat. If the mean temperature exceeds the value set here, the return setpoint temperatures are reduced to a minimum and the heating circulation pumps switched off. If the mean temperature falls below the set heating limit, heating mode is resumed automatically.</p>	<p>Switching on / off of the heating limit</p> <p>heating limit enabled</p> <p>heating limit switched off</p>
---	---

<p>parallel mode </p> <p>No</p> <p>Master</p> <p>Slave</p>	<p>Combination of up to 4 heat pumps</p> <p>heat pump works independently</p> <p>heat pump is the parallel mode master and takes over the heat control of the system</p> <p>heat pump is part of a parallel mode and receives commands from the master for heating and domestic hot water preparation</p>
--	---

→ page 44, "Program area Parallel mode"

<p>remote maintenance </p> <p>Yes</p> <p>No</p>	<p>Connection to the remote maintenance server Heatpump24.com</p> <p>Remote maintenance function switched on</p> <p>Remote maintenance function switched off</p>
---	--

→ page 41, "Remote maintenance"

<p>pump optim. time </p> <p>If the pump optimisation is switched on (→ Pump opt. = Yes), the time be defined, according to which the heating circulation pumps are switched off.</p> <p>If the heat pump is off during this time because there is no need for heating, the pump will loop - 30 minutes off, 5 minutes on, until there is a further heating requirement.</p>	<p>flow VBO </p> <p>→ page 36, "Pump flow lead time"</p>
<p>defrost cycle min </p> <p>Defrost cycle time, minimum time between two defrost processes</p> <p>Take the time to be set from the instructions for use for the respective L/W appliance.</p>	<p>reduction 2 VD </p> <p>Shortening second compressor stage</p> <p>Time before the second compressor stage cuts in. If the difference between the return flow set and actual values is greater than the setting "Hysteresis 2.CP short", then the second compressor stage cuts in after this time.</p>



**NOTE**

A compressor may not switch on in more than three times per hour. If this figure has already been reached, cutting in is postponed.

<p>TDI message </p> <p>Yes</p> <p>No</p> <p>heat source </p> <p>No</p> <p>brine</p> <p>wat./brine</p> <p>water</p>	<p>Thermal disinfection signal</p> <p>see error number 759</p> <p>→ page 51, Error number 759</p> <p>fault signal/message does not arrive</p> <p>Heat source medium used</p> <p>Factory setting on delivery and for service purposes</p> <p>Brine (= operation without intermediate heat exchanger). If this option is selected, the temperature of "min. heat source temp" will be set automatically.</p> <p>Brine-water mixture operates on the secondary side of the intermediate heat exchanger. If this option is selected, the temperature of "min. heat source temp" will be set automatically.</p> <p>Water operates on the secondary side of the intermediate heat exchanger. If this option is selected, the temperature of "min. heat source temp" will be set automatically.</p> <p>Duration until the additional heating generator is released in heating mode</p> <p>Duration until the additional heating generator is released in domestic hot water preparation</p>
--	--

The additional heating generator is activated immediately (time setting = 0) or after the set time has elapsed in order to support the heat pump in domestic hot water preparation and to reach the desired domestic hot water temperature as quickly as possible.

→ page 34, "Inverter"







As long as the ventilation program is active, the corresponding program symbol will appear in the navigation screen :



### Fix startup parameters

→ page 13, "Fix startup parameters"

### Back up error memory externally

#### NOTE

Use of the function requires customer service access.



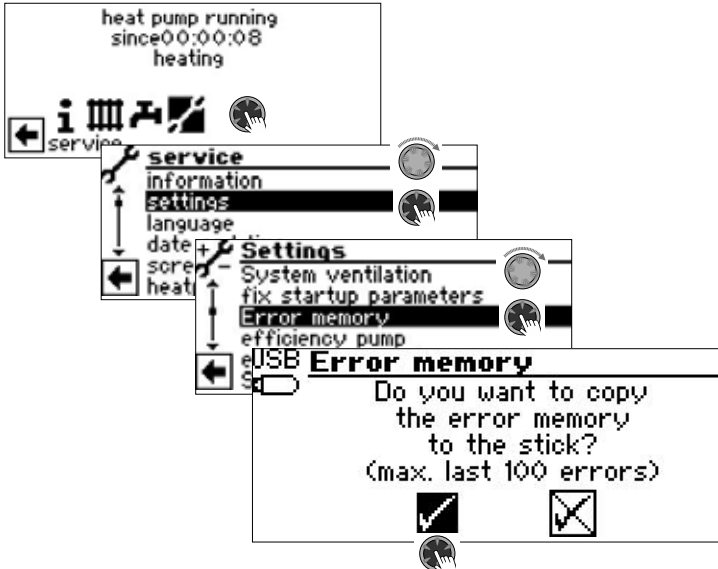



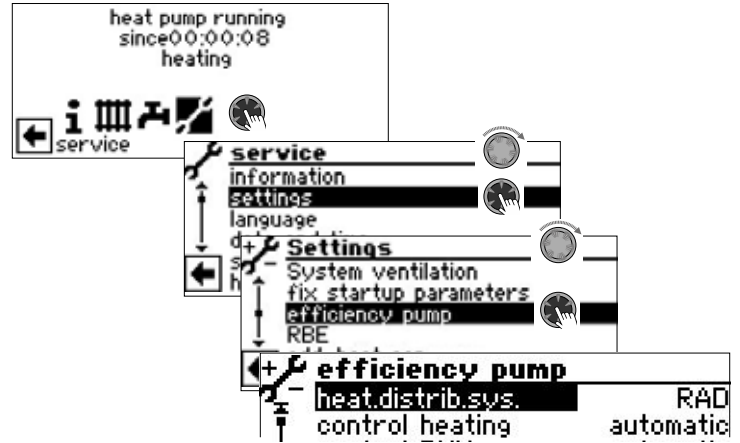



The internal error memory of the heating and heat pump controller can be copied to a USB stick. In doing so, a maximum of the last 100 errors that occurred are copied.



### Efficiency pump



The menu is not shown in full here.

- Heat distrib. sys  Heat distribution system
  - RAD Radiator(s)
  - UFH Underfloor heating
- control heating  Control of the heating circulation pump
  - Auto Automatic control
  - Manual Additional menu entries visible:
    - output heat. nom.
    - output heat. Min.
 Nominal and minimum power of the heating circulation pump (limitation for flow noise) can be manually adjusted
- Output heat. max.  Maximum performance of heating circulation pump (only with "control heating = auto" visible and adjustable)
- Control DHW  Control of the domestic hot water charging pump
  - Auto Automatic control
  - Manual Additional menu entry visible:
    - output dhw.
 Performance of the DHW charging pump manually adjustable
- output dhw max.  Maximum performance of dhw charging pump (only with "Control dhw = auto" visible and adjustable)
- output cooling  Maximum performance of cooling
- control VBO  Control of the brine circulation pump
  - Auto Automatic control
  - Manual Additional menu entry visible:
    - output VBO
 Performance of the brine circulation pump manually adjustable
- output VBO (cooling)  Performance of the brine circulating pump during cooling
- dT cooling  Setting the cooling temperature difference in K
- Set bypass valve  Setting the bypass valve
- Control signal CP Current value can be read off as %
- Flow rate existing Current value can be read off as l/h

Save settings.







## Enter serial number

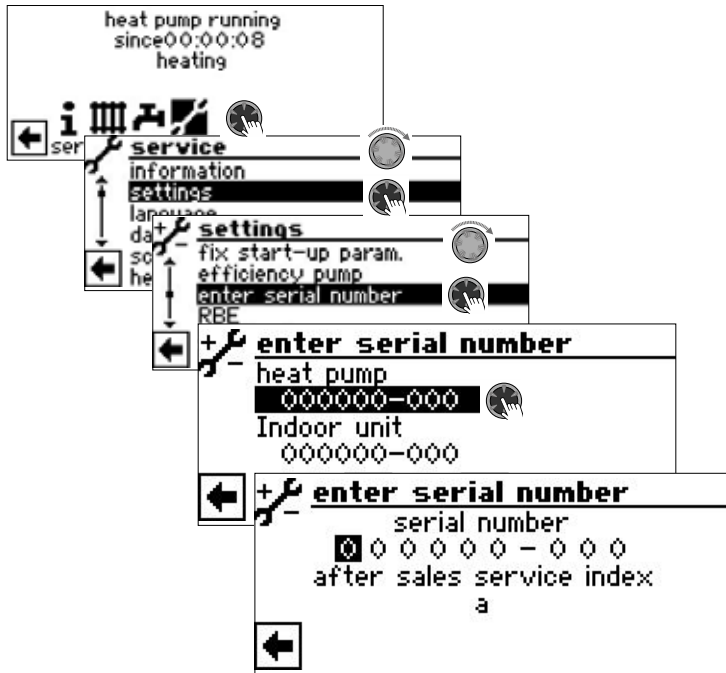

Heat pump

Indoor unit

Serial number of the heat pump

Serial number of the hydraulic station, hydraulic module or wall-mounted controller (only required if the heating and heat pump control is not integrated in the heat pump)

### NOTE

The serial number can be found on the name plate attached to respective unit.

Save settings.



## RBE – room control unit

If the system has a RBE room control unit (extra-cost accessory), this is set here:

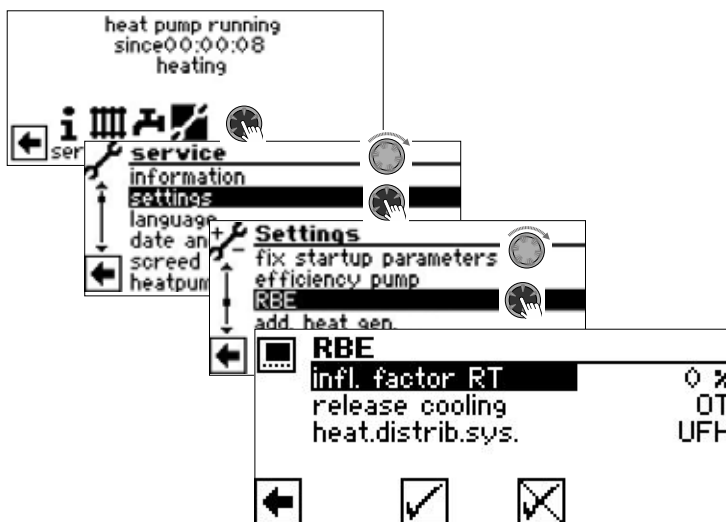

→ Operating manual RBE – room control unit

## Additional heating generator

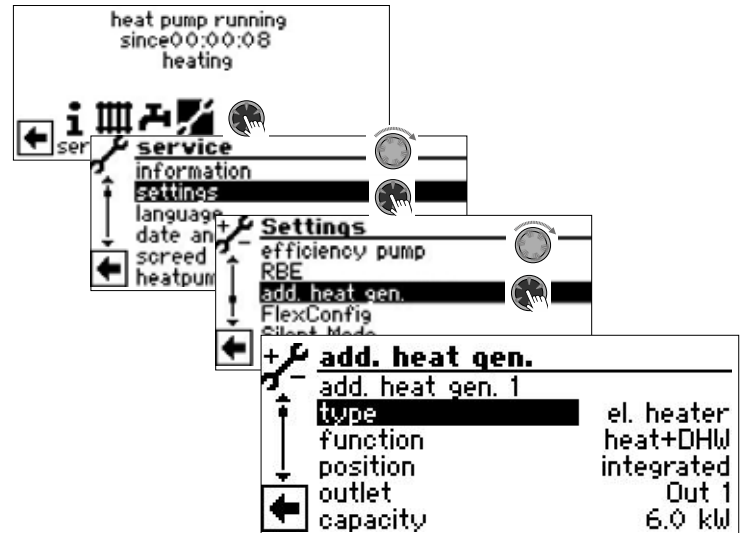

Here you can activate connected additional heating generators and set their parameters or deactivate connected heat generators

### NOTE

The possible settings depend on the respective unit type. If several additional heating generators are connected you can go to their settings by using the “Rotary pushbutton” to scroll up or down (no submenu field may be activated during this scrolling).

Add. heat. gen. 1 Selected additional heating generator 1 (ZWE 1)

Type	
No	no ZWE 1 connected, system operates monovalently
El.heater	Electric heating element with bivalent level control for heating element ( <i>not released during the El. sup. blockade</i> )
Boiler	Heating boiler with bivalent level control for the boiler ( <i>in bivalent level 3 is on continuously, until switched back to bivalent level 2</i> )
Therme	Water heater with bivalent level control for water heater ( <i>control behaviour is analogous to that of a heating element; however, is also active during El. sup. blockade</i> )
Function	
No	without function
Heating	Heating
heat+DHW	Heating and Domestic hot water)
Position	
Tank	Integrated in the heat generator (= heat pump or associated hydraulic component)
Integrated	Integrated directly in or on the heating or hot water storage tank
---	no ZWE 1 connected
Outlet	The corresponding output contact for electrical connection of the ZWE is displayed automatically. If a type of preparation is selected under “Type”



	and it is displayed here as outlet "---", the wiring has already been laid in the factory.
capacity	The heat quantity and the energy input for a connected electric heating element are calculated based on the value set here. If more than one heating element is connected to the ZWE 1 terminal, the total sum of their capacity must then be set.
Add. heat. gen. 2	Selected additional heating generator 2 (ZWE 2)
Type	
No	no ZWE 2 connected
El. heater	Electric heating element with bivalent level control for heating element ( <i>not released during the El. sup. blockade</i> )
Function	
No	without function
Heating	Heating
Domestic hot water	Domestic hot water
	If activated, no ZWE 1 used for domestic hot water heating
Position	
Tank	Integrated directly in or on the heating or hot water storage tank
---	no ZWE 2 connected
Outlet	The corresponding output contact for electrical connection of the ZWE is displayed automatically. If a type of preparation is selected under "Type" and it is displayed here as outlet "---", the wiring has already been laid in the factory.
capacity	The heat quantity and the energy input for a connected electric heating element are calculated based on the value set here. If more than one heating element is connected to the ZWE2 terminal, the total sum of their capacity must then be set.

## Inverter

The "Inverter" function makes it possible to control the operating frequency of the compressor - and thus the output.

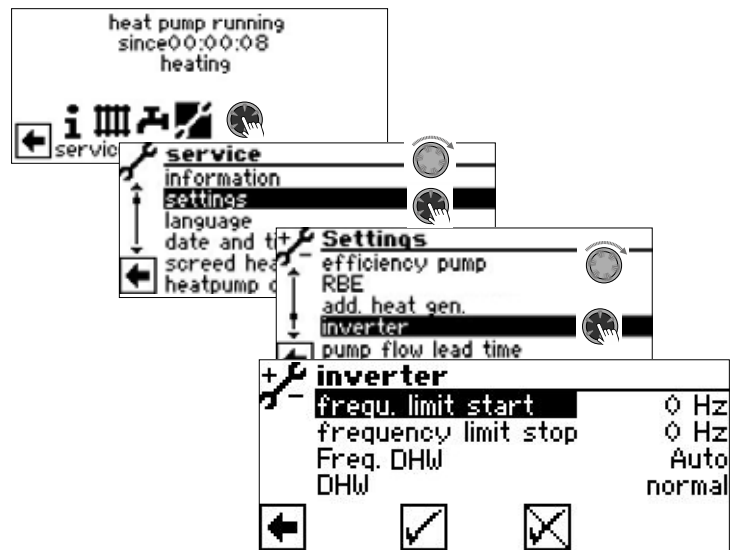

frequ. limit start	Lower limit of the operating frequency (rotational speed) of the compressor
frequency limit stop	Upper limit of the operating frequency (rotational speed) of the compressor
Freq. DHW	Frequency specification for domestic hot water preparation
Auto	Automatic frequency specification
Hz	Manual setting of a fixed speed for domestic hot water preparation
DHW	Power control for domestic hot water preparation
normal	Standard automatic mode (= energy-efficient domestic hot water preparation)
luxury	Increased performance in automatic mode (= faster domestic hot water preparation)



### NOTE

The "luxury" setting increases the energy consumption. If the power of the heat pump at the "luxury" setting is not sufficient to reach the desired domestic hot water temperature:

- ▶ In the system setting "Freig. ZWE WW", set a time from which the electric heating element / the electric heating rod is to be switched on.

→ page 30, "Freig. ZWE WW"



## FlexConfig

The “FlexConfig” function enables the individual configuration of selected outputs on the heating and heat pump controller board. Note that only certain functions are available for each output.

### NOTE

For safety reasons, FlexConfig settings can only be made directly on the control unit of the heating and heat pump controller.

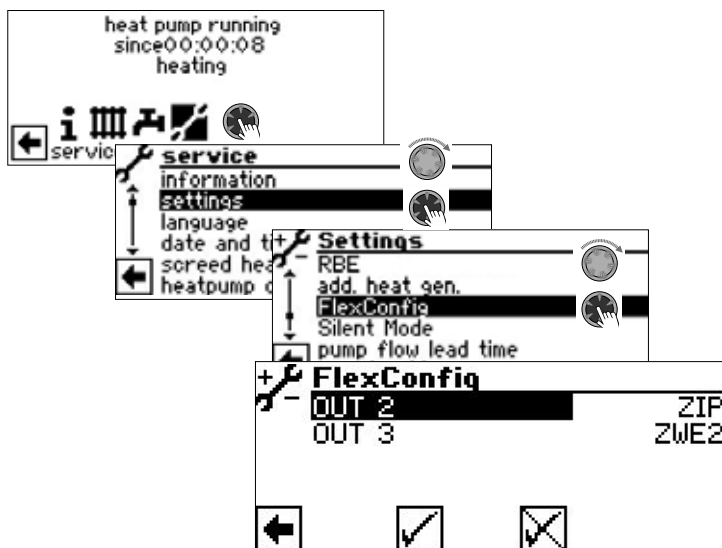

#### OUT 2

- ZIP  
KS
  - BLP
  - Enth
  -
- Circulation pump  
Cooling signal (active when cooling enabled)  
Domestic hot water charging pump (active for domestic hot water demand, continues running for 30 s)  
desuperheater  
If selected, hot gas usage is switched on (→ page 27, “Hot gas utilisation / desuperheater”).  
not used

#### OUT 3

- ZWE2  
FP1  
---
- Additional heating generator 2  
Circulation pump mixing circuit 1  
not used

### ! IMPORTANT

If settings are changed, warnings may appear on the screen – as soon as these settings are saved. These must be strictly adhered to.

## Silent Mode

Some air/water heat pumps offer “Silent Mode” in addition to standard operation. This is a low-noise operation and may also have several stages, depending on the type of device. In low-noise operation, compressors are limited in power and fans in speed. However, this means that their maximum heating power can no longer be called up. To maintain comfort, the required power difference is compensated out by an additional heating generator (usually an electric heating element). The higher heating element contribution to the heating power can result in higher heating costs.

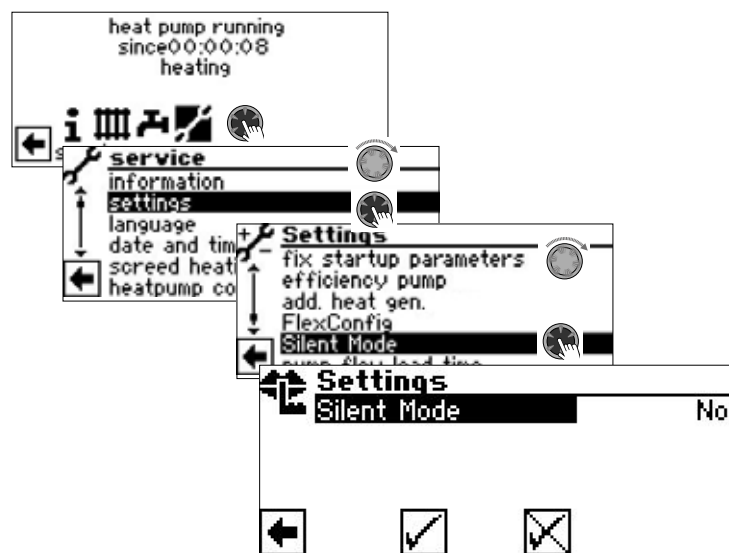

#### Silent Mode

- No
  - Yes
- Factory setting  
Silent Mode switched on

If “Silent Mode” is switched on, the menu field “Timers” for programming the operating times appears - after the menu has been exited and then called up again:

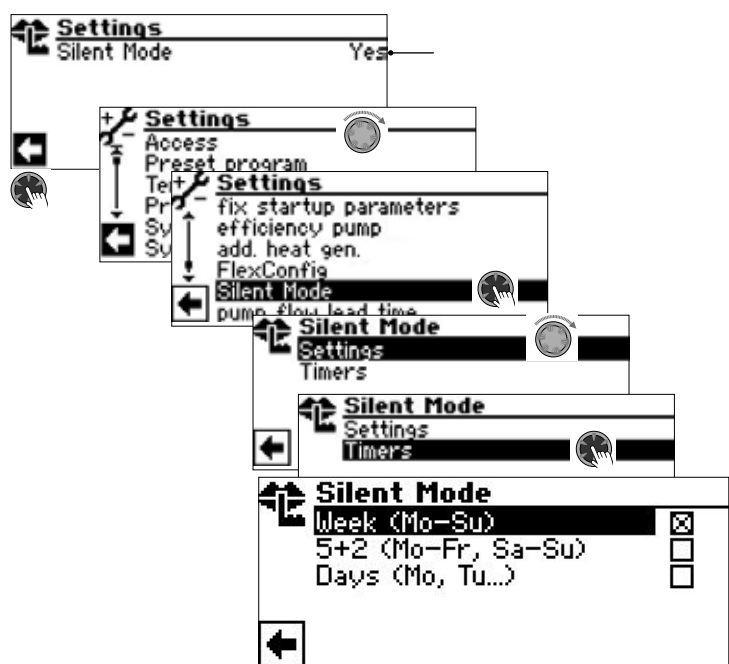

The “Silent Mode” operating times are programmed as described in the section “Setting the time programs of the heating circle”



→ Part 1 of the controller manual, program area "Info and Quick Setting", section "Setting the time programs of the heating circle".

During the set times, the heat pump operates in low-noise mode.

## Pump flow lead time

### NOTE

Changing settings requires installer or customer service access.

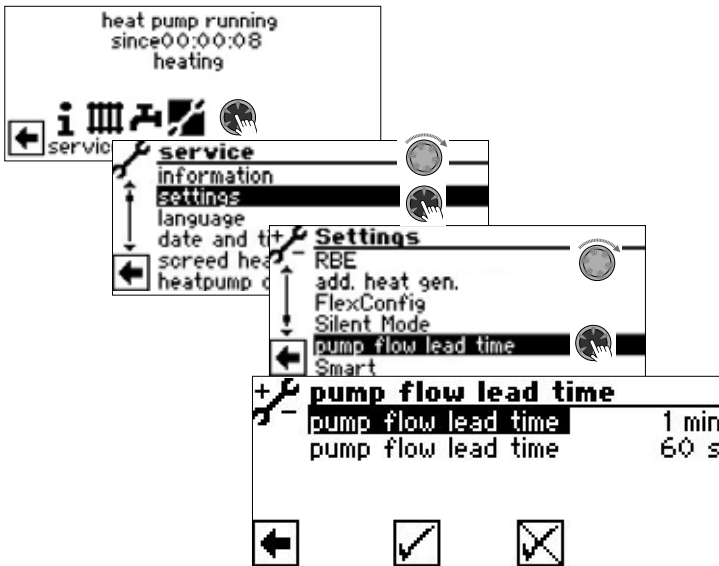

- Pump flow lead time VBO Pump flow lead time brine circulation pump VBO  
Feed-time for the heat-source pump in brine/water or water/water appliances can be set here. This may be necessary if the time from switching on the pump until the nominal rate of flow is reached is > 30 seconds. The setting is mirrored in the menu "System settings" in the line "flow VBO" and can also be made there.
- Pump flow lead time ZUP Pump flow additional circulation pump ZUP

## Smart

The "Smart" menu item only appears if individual room controller (extra-cost accessory) is connected to the heating- and heat pump control and the "Smart" option is set under "remote control" (→ "Service > Settings > System settings").

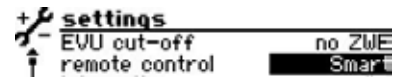

If these requirements are met, settings must be made in the "Smart" menu in order to operate the heating and heat pump controller conveniently via mobile iOS/Android devices.

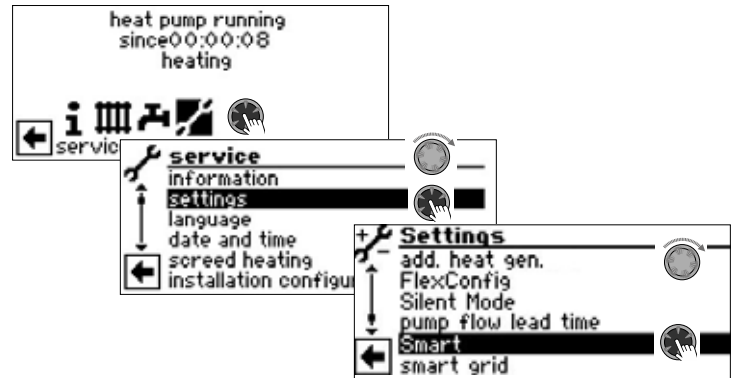

→ Operating manual „alpha home“

## Smart Grid

Use of the Smart Grid function requires the availability of the Smart Grid functionality in your electricity tariff as well as special wiring.

→ page 38, "Terminal diagrams Smart Grid"

- NOTE**  
When the EVU disabling is applied, then the Smart Grid function may not be activated.
- NOTE**  
The menu item only appears if the "Smart Grid" option (→ "Service > Settings") is set to "Yes".

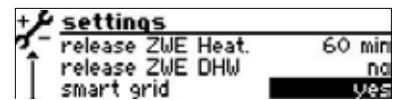

Changing settings requires installer or customer service access.



## Operating states

Smart Grid is connected via two contacts of the EVU blocking time, from which four possible operating states result.

EVU 1	EVU 2	Operating status
ON (1)	OFF (0)	<b>1 (= EVU blocking time)</b> The heat pump sets a new setpoint value for the heating, which is lowered by the value "decrease heating". The set HR heating hysteresis applies. <b>Heating:</b> The heat pump operates in the "setpoint value" range minus "decrease heating" +/- HR heating hysteresis in heating mode. <b>NOTE</b> Higher decreases in temperatures can lead to loss of comfort in Smart Grid operation. <b>Domestic hot water preparation:</b> normal preparation.
OFF (0)	ON (1)	<b>3 (= normal operating mode)</b> The target temperature is the set setpoint temperature for heating water and domestic hot water. These set temperatures are held taking into account the respective hysteresis.
ON (1)	ON (1)	<b>4 (= increased operating mode)</b> The heat pump sets a new setpoint value for the heating, which is then increased by the "increase heating" value. The set HR heating hysteresis applies. <b>Heating:</b> The heat pump operates in the "setpoint value" range plus "increase heating" +/- HR heating hysteresis in heating mode. <b>NOTE</b> Higher increases in temperatures can lead to loss of comfort in Smart Grid operation. The return flow limitation temperature must be inspected with integration of a storage tank in series. <b>Domestic hot water preparation:</b> The heat pump sets a new setpoint value for the hot water, which is then increased by the "increase hot water" value. The set hysteresis for hot water applies.

## Set decrease / increase

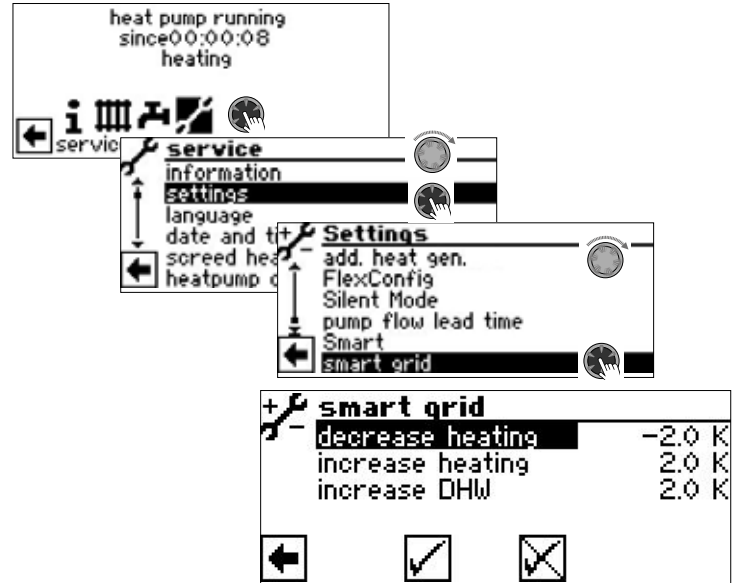

- Decrease heating Temperature difference in K for heating circuit in operating state 2
- Increase heating Temperature difference in K for heating circuit in operating state 4
- Increase DHW Temperature difference in K for domestic hot water heating in operating state 4

**NOTE**  
 Priority controlling is still retained in Smart Grid operation. Return flow limitation temperature (return flow limitation) and flow maximum are also monitored in Smart Grid operation.



## Terminal diagrams Smart Grid

SW H3 • SWC(V) H1/H3 • WZS(V) H3 • PWZSV H1/H2/H3

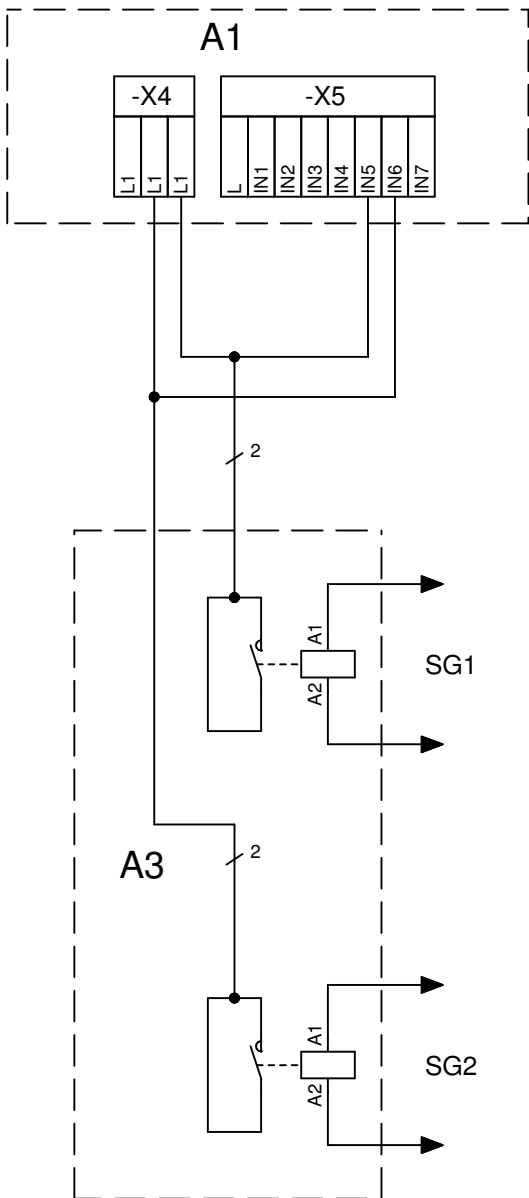

Legend:	UK 831211a	
Equipment	Function	
A1	Controller board; Attention: I-max = 6,3A/230VAC	
A3	Sub-distribution unit internal installation	
SG1	IN5	Smart Grid activation 1
SG2	IN6	Smart Grid activation 2

LWCV • LWDV • LW(A)V • LW(A)HV • LWAV+ • Paros • Hybrox  
• LWP

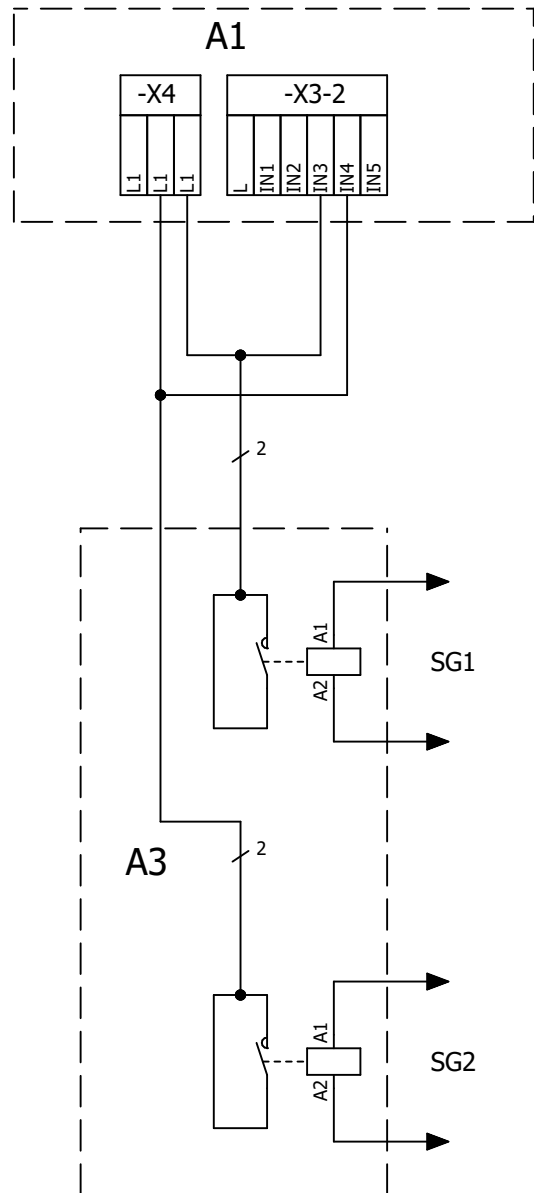

Legend:	UK 831210	
Equipment	Function	
A1	Controller board; Attention: I-max = 6,3A/230VAC	
A3	Sub-distribution unit internal installation	
SG1	IN3	Smart Grid activation 1
SG2	IN4	Smart Grid activation 2

### SELECTING LANGUAGE OF THE SCREEN DISPLAY

→ Part 1 of the controller manual, section "Basic Information on the operation".

### DETERMINING DATE AND TIME

→ Part 1 of the controller manual, section "Basic Information on the operation".





## SCREED HEATING PROGRAM

The screed heating program is used for automatic heating of screed floors. To do so, the system runs through the ten steps of supply target temperatures in the menu for the respective assigned time intervals. As soon as all stages have been completed, the screed heating program ends automatically.

The outdoor temperature is fixed at -10 °C during the screed heating program in order to avoid various shutdown causes or to guarantee the full functionality of an additional heating generator.

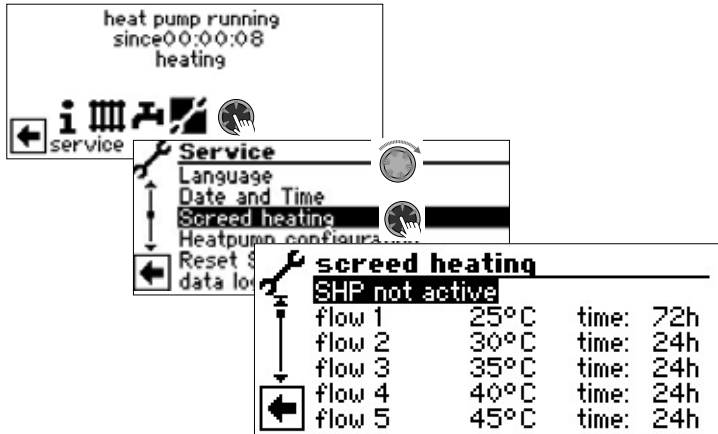

### NOTE

Values of the factory setting correspond to the specifications of some screed manufacturers, but can be changed on site.

### IMPORTANT

Always check values of the factory setting or desired values in respect to whether they correspond to the manufacturer specifications for the screed which is to be heated.

## Setting temperatures and time intervals

Example:

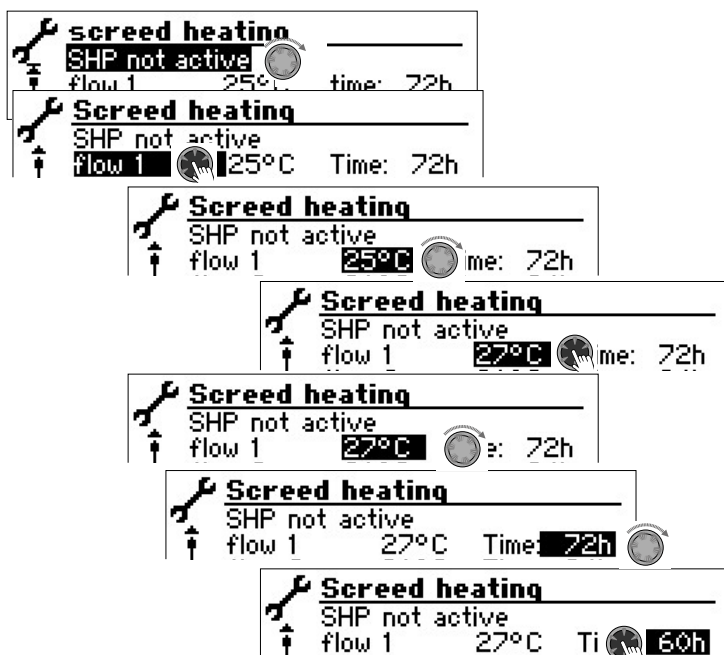

Procedure repeat for the table lines "Flow2" to "Flow10".

### NOTE

If less than ten levels are required for heating the screed, set the time interval to "0h" for all levels not required.

### IMPORTANT

Do not start any domestic hot water high-speed charge while the screed heating program is running.

### NOTE

If the temperatures in the heating system are greater than the setpoint temperature of the first flow temperature level, start the screed heating program with the next highest flow temperature level. Otherwise the screed heating program can trigger an error message in the first flow temperature level.

In order to achieve the desired flow target temperatures, compressors and additional heating generators are available depending on the setting in the "Mode of operation Heating" menu:



Auto	Compressor switches on on demand ZWE switches on from bivalence stage 3
add. heat gen.	Compressor never switches on ZWE switches on immediately
Off	Compressor switches on on demand ZWE never switches on

Mixing circuits can be integrated into the screed heating program. The controller then attempts to regulate the current temperature setpoint of the screed heating program at the respective flow sensor by opening or closing the mixing circuit valve. The mixing circuit control and temperatures have no influence whatsoever on the sequence of the screed heating program.

To release the function for a mixing circuit, the respective mixing circuit must be set as "Discharge". In addition, the option "w. mixer" must be set under the "Screed heating" system setting.



## Starting screed heating program

**NOTE**  
While the screed heating program is running, -10°C is displayed as the outdoor temperature. It is not possible to heat water.

**NOTE**  
In the screed heating program, all connected heat generators are released if necessary. However, the following applies:  
A heating system is designed for heating in general and not for heating screed. It may therefore be necessary for the screed heating phase to integrate additional heating generators in the system.

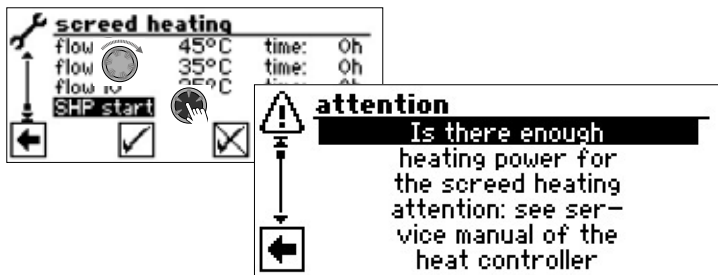

The menu is not shown in full here.  
scroll down the screen.  
Answer the confirmation prompt.

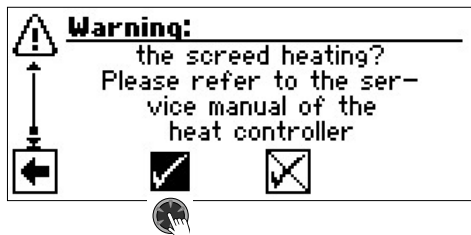

**NOTE**  
If you respond to the confirmation prompt with , the screen will change back to the menu "Screed heating".

After starting the screed heating program, the programmed flow temperature levels are automatically executed in succession. The time interval set for a flow temperature level is not necessarily the actual time which is necessary to reach the next flow temperature level. Depending on the heating system and power of the heat pump, it may take varying lengths of time until the next flow temperature level is reached.

If a flow temperature level is not reached on account of too low a heating power, a corresponding error message will appear in the screen. The error message informs you about the flow temperature level which has not been reached. However, the screed heating program continues running and attempts to reach the next flow temperature levels.

**NOTE**  
After expiry of a flow temperature level, the relevant time interval is set to "0h". This ensures that the screed heating program continues after a potential power failure at the start of each flow level at which it was interrupted.

**NOTE**  
If the error message "Power screed heating" appears (= error number 730), this is only an indication that the screed heating program could not process a flow temperature level in the specified time interval. The screed heating program continues to run nevertheless. The error message can only be acknowledged if the screed heating program has finished or has been manually switched off

As long as the screed heating program is running, the corresponding program symbol  will appear in the navigation screen:



## Manually terminating screed heating program

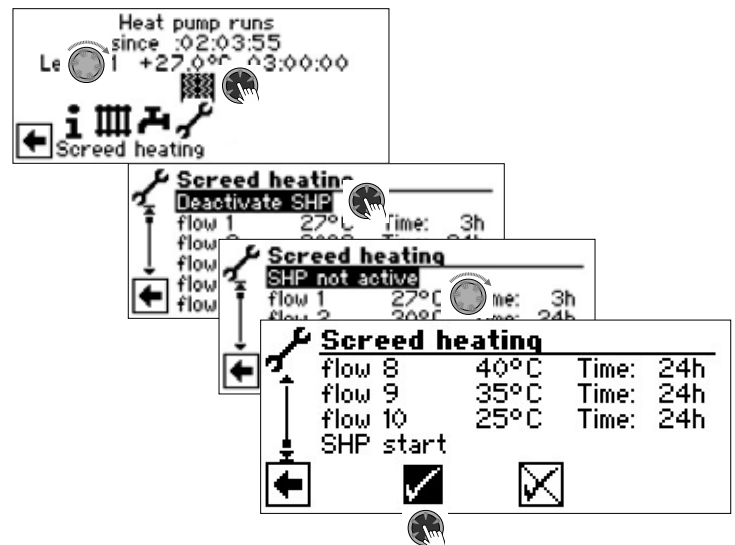

## HEATPUMP CONFIGURATION

### **NOTE**

If there is a type of use which is not required for your system, it is not necessary for the associated program areas to be represented in the screen.

An example: Your system is only designed for heating mode. No components are installed for the domestic hot water preparation. That means you do not require access to the menus of the program area "Domestic hot water". It is therefore not necessary for these menus to be shown in the screen. In the menu "Heatpump configuration" you can specify that these menus do not appear in the screen and therefore remain hidden.

### **NOTE**

However, hiding a menu does not affect the function or operation of a type of use. If the type of use is switched off, this must be set in the menu "Mode of operation".

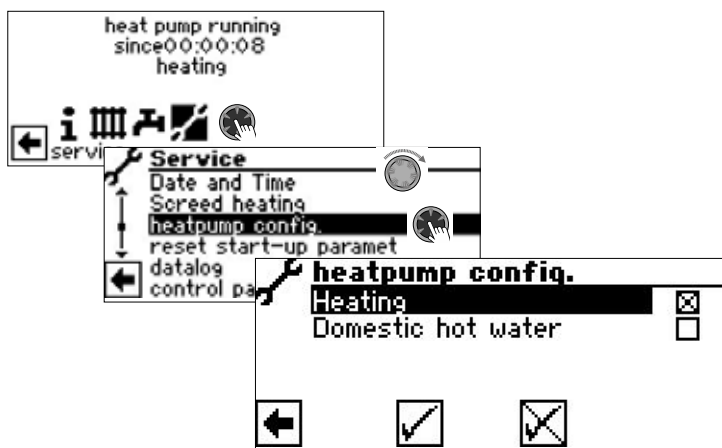

Deselect program area not required.  
The example shown reveals that the menus of the program area "Heating" are displayed in the screen. The menus of the program area "Domestic hot water" are not displayed.

## STARTUP GUIDE

→ page 12, "Startup guide"

## RESET START-UP PARAMETERS

→ page 13, "Reset start-up parameters"

## DATA LOGGER

→ Part 1 of the controller manual, program area "Service", section "Data logger".

## CONTROL PANEL

### Adjusting the contrast of the control unit display

→ Part 1 of the controller manual, program area "Service", section "Basic Information on the operation"

### Web server

→ Part 1 of the controller manual, program area "Service", section "Control Panel / Web server"

### Remote maintenance

The "Remote maintenance" function enables data exchange between the heating and heat pump control and the remote maintenance server Heatpump24.com. Remote monitoring and remote access to the heating and heat pump control is possible via Heatpump24.com..

The following prerequisites must be fulfilled:

- The heating and heat pump control has access to the internet via a broadband connection (DSL) and via a router with open port TCP 443 (HTTPS).
- A valid DNS server is set.
- The current time (date and time, correct time zone) is set in the heating and heat pump control.

Check date, time and time zone and correct if necessary..

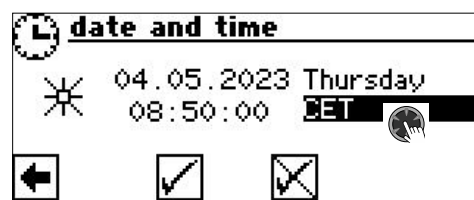

Click on the time zone abbreviation and set the location of the heating and heat pump controller.

- The manufacturer makes available a completed application form for remote maintenance.
- A contract with the manufacturer has been negotiated.

### **NOTE**

Remote maintenance is an additional service feature made available by the manufacturer at an additional cost.

### **NOTE**

All settings that are related to the "Remote maintenance" function, may only be handled by authorised service personnel.



## Switch on the remote maintenance function

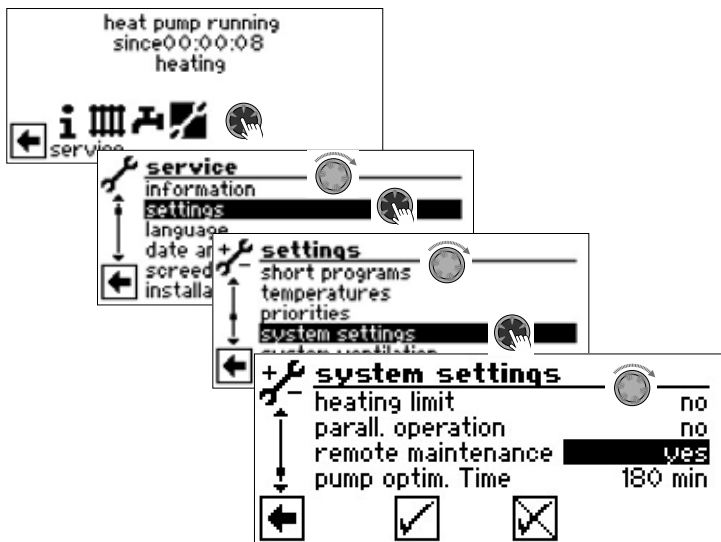

## Check connection

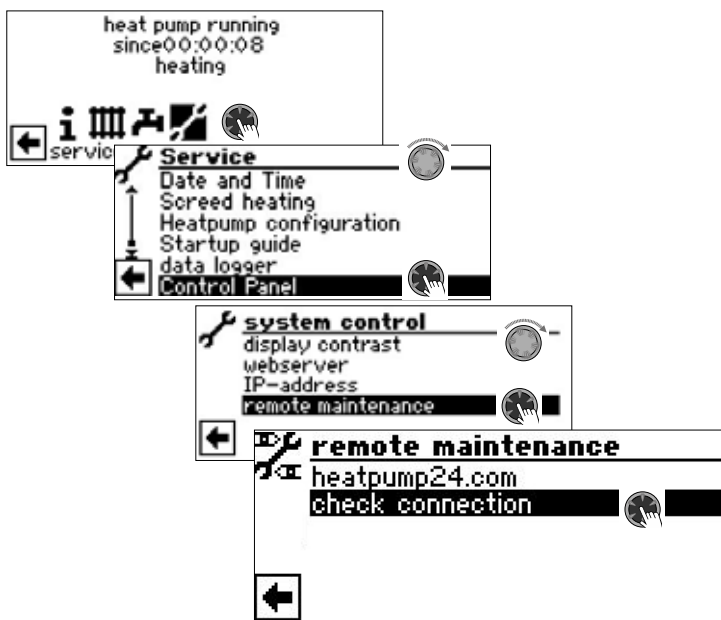

The "Remote maintenance" function can only be used if the serial number of the heat pump has been entered in the heating and heat pump control.

If the heating and heat pump control is not integrated in the heat pump, the serial number of the indoor unit must also have been entered.

If this is the case, the connection will be checked.

If this is not the case, a menu appears that requires the serial number to be entered. The entry of the serial number is possible at this point from the "User" access.

→ page 33, "Enter serial number"

As soon as the serial number is entered and saved, the check of the connection starts. The result is displayed on the screen of the heating and heat pump control.

## Error causes with connection problems

If a connection with the remote maintenance server is not possible, the causes may include:

- The heating and heat pump control has no connection to the internet.
- The IP address of the heating and heat pump control is not adapted to the local network.
- TCP port 443 (HTTPS) is not activated for the heating and heat pump regulator.
- The standard gateway in the "System control / IP address" is not correctly set up.
- The set DNS server is not accessible.
- Date and time set in the heating and heat pump control are not up to date.

If connection problems arise, check all settings associated with "Remote maintenance", "Web server", and "System control / IP address". Correct the settings as needed.

If, thereafter, a connection with the remote maintenance server is still not possible, contact the customer service representatives of the manufacturer.

## Heatpump24.com

### Query informations Heatpump24.com

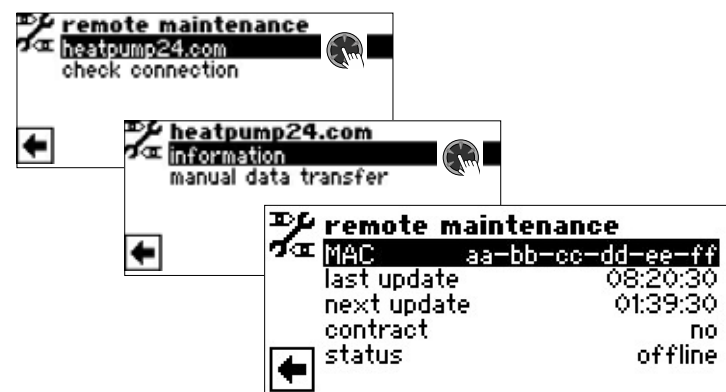

MAC	MAC address of the heating and heat pump control Data must be shared with the manufacturer by the time the contract is signed
last update	Elapsed time since last automatic data transfer to Heatpump24.com
next update	Time until next automatic data transfer to Heatpump24.com
contract	Type of remote maintenance contract concluded
status	offline = no connection to Heatpump24 .com connect = connection to Heatpump24 .com is being established online = connection to Heatpump24 .com is established and active

## Manual data transfer to Heatpump24.com

If necessary, the data can be transferred to Heatpump24.com manually.

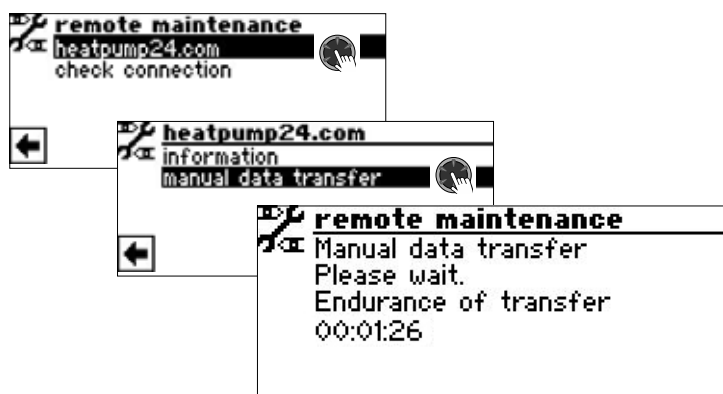

If connection problems arise, a warning message will appear.

→ page 42, "Error causes with connection problems"



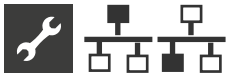

## Program area “Parallel mode”

### BASIC INFORMATION

The parallel mode makes it possible to connect up to four heat pumps so that they work together in a common heating system.

Parallel mode can be established either with LWP heat pumps or with Hybrox heat pumps.

The connection to the parallel mode is made via the Ethernet interface on the control unit of the heating and heat pump control. The control unit is either attached directly to the individual heat pump or to the indoor unit of this heat pump.

 **NOTE**  
Identical software versions must be installed on the interconnected heating and heat pump controls.

 **NOTE**  
Individual room control with alpha home is not possible in parallel mode.

If more than 2 heat pumps or associated indoor units are to be connected to each other, a hub or switch (accessory) is required.

One of the interconnected heat pumps takes over the control of the heating and cooling of the entire system. The other heat pumps operate as “slaves”.

 **NOTE**  
Only one of the interconnected heat pumps may be set as master.

The outdoor sensor and the external return flow sensor (TRLext) of the heating system must be connected to this master.

The el. sup. blockade must be connected to each individual heat pump. In the event of an el. sup. blockade on the master, heating or cooling is also blocked at the slaves.

Only one slave heat pump of the parallel mode can be used for domestic hot water preparation. To be able to prepare domestic hot water using this slave heat pump, the associated domestic hot water sensor must be connected to this slave heat pump.

While this slave heat pump is preparing domestic hot water, it is excluded from the control compound for heating and cooling and is not controlled by the master heat pump.

 **NOTE**  
With parallel mode, the program section “Photovoltaics” can only be used on the master. The prerequisite for this is an installed Expansion board in the heating and heat pump control of the master.  
With parallel mode, the program section “Swimming pool heating” can only be used on a slave. The prerequisite for this is an installed Expansion board in the heating and heat pump control of this slave.

If heating or cooling is required, the compressor with the fewest operating hours (compressor running time) is switched on first. Depending on the requirement, further compressors are switched on in the appropriate manner.

The individual compressors are always enabled regardless of the outside temperature and cannot be disabled.

### Switching on and off for LWP heat pumps

The second compressor is only switched on when all first compressors of all LWP heat pumps are running.

After the end of the heating or cooling demand, the compressor of the slave that was switched on first is switched off first.

### Switching on and off for Hybrox heat pumps

Slaves are also switched on when the compressors of all heat pumps that are already active have an average load of 60 %.

After the end of the heating or cooling demand, the compressor of the slave with the most operating hours (compressor running time) is switched off first.

- Setpoint and TRLerh max. are in excess (all slaves are switched off immediately)
- Setpoint and hysteresis “HC time” / “cooling time” for “HC time” are in excess

### BROKEN CONNECTION

If the connection between heat pumps is broken for more than 5 minutes, an error is displayed on the screen of the control unit. Depending on the device either 756 (“Lost connection to master”) or 755 (“Lost connection to slave”).

→ page 50, “Error Diagnosis / Error messages”

## CONNECTION

**Example 1:** Connection of the Ethernet interfaces of the control units via hub or switch (accessory)

4 heat pumps for heating mode, 1 of these heat pumps is also responsible for domestic hot water preparation

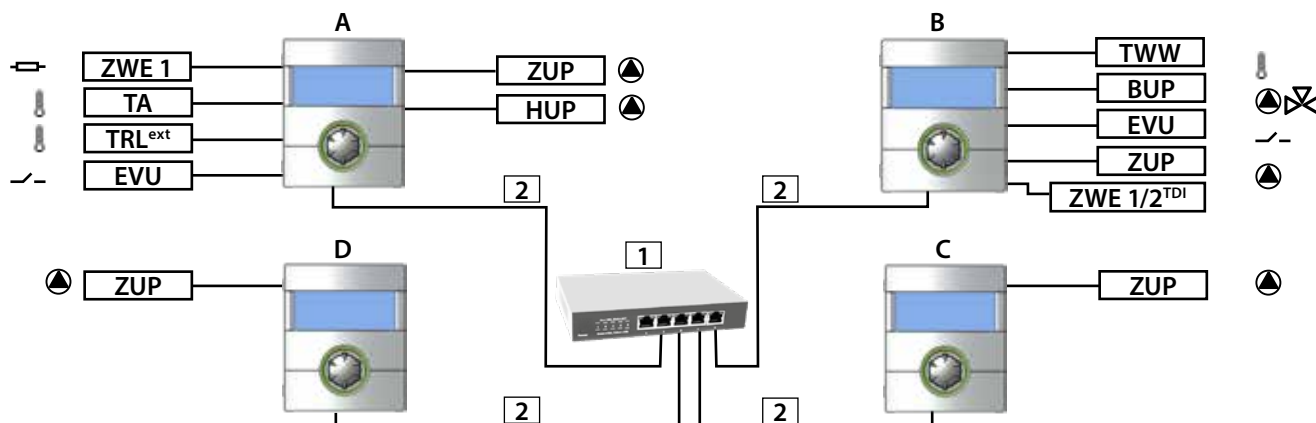

**Example 2:** Connection via the Ethernet interfaces of the control units

2 heat pumps for heating mode only

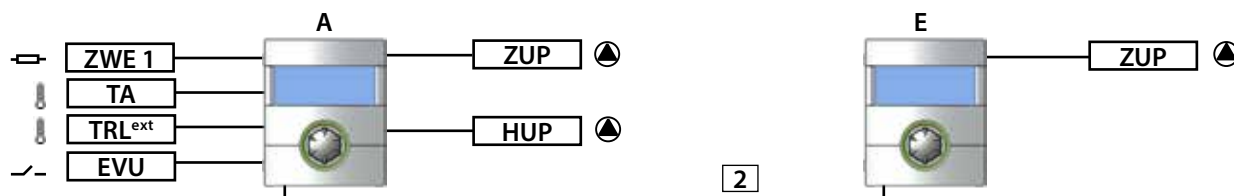

**Example 3:** Connection via the Ethernet interfaces of the control units

2 heat pumps for heating mode, 1 of these heat pumps is also responsible for domestic hot water preparation

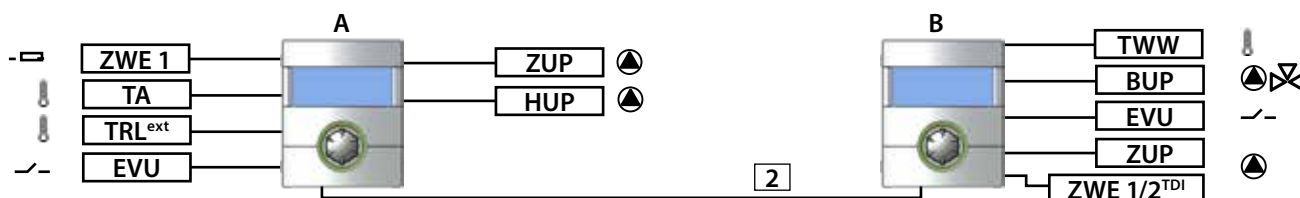

- |                        |   |                                  |
|------------------------|---|----------------------------------|
| TWW                    | Domestic hot water temperature sensor                                     |                                  |
| ZWE 1                  | Second heat generator 1   |                                  |
| TA                     | External senso  |                                  |
| TRL <sup>ext</sup>     | External return flow sensor   |                                  |
| EVU                    | Release signal electric suppl.  |                                  |
| BUP                    | Domestic hot water pump   |                                  |
| ZUP                    | Additional circulation pump   |                                  |
| HUP                    | Heating circulation pump  |                                  |
| ZWE 1/2 <sup>TDI</sup> | Second heat generator 1 oder 2 (only possible for "Thermal disinfection") |                                  |
| <b>1</b>               | Hub or switch with at least 4 ports                                       | RJ-45, 10 Base-T / 100 Base-Tx   |
| <b>2</b>               | Patch cable   | RJ-45 (up to 20m)                |
| <b>A</b>               | Heat pump Master  | (in this case heating only)      |
| <b>B</b>               | Heat pump Slave 1   | (heating and domestic hot water) |
| <b>C</b>               | Heat pump Slave 2   | (in this case only heating)      |
| <b>D</b>               | Heat pump Slave 3   | (in this case only heating)      |
| <b>E</b>               | Heat pump Slave 1   | (only heating)                   |

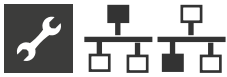

## ADDITIONAL HEAT GENERATOR

### Master – heating mode

For LWP:

ZWE1 and ZWE3 can be used at the master, but only for heating mode.

Second heat gen. 1 type: el. heater  
 Second heat gen. 1 function: heat+DHW  
 Second heat gen. 1 position: integrated

Second heat gen. 3 type: boiler  
 Second heat gen. 3 function: heat+DHW  
 Second heat gen. 3 position: tank

For Hybrox heat pumps:

ZWE1 can be used at the master, but only for heating mode. Other ZWE cannot be used on the master.

Second heat gen. 1 type: el. heater  
 Second heat gen. 1 function: heat+DHW  
 Second heat gen. 1 position: integrated

After switching on the last compressor, ZWE1 switches on after HC time has elapsed (for LAP heat pumps after double the HC time has elapsed).

The outdoor temperature release ZWE is blocked on the master.

### Slave –preparing domestic hot water

ZWE1 and ZWE2 can be used on each slave, but only for domestic hot water preparation.  
 The corresponding settings must be made on the respective slave.

Second heat gen. 1 type: el. heater  
 Second heat gen. 1 function: heat+DHW  
 Second heat gen. 1 position: integrated

Second heat gen. 2 type: el. heater  
 Second heat gen. 2 function: DHW  
 Second heat gen. 2 position: tank

## MIXING CURCUITS

Each of the connected heat pumps can control 2 mixing circuits (3 with the expansion board installed) like an independent device. The settings for these mixing circuits must then be made on the respective heat pump.

## ENERGY MONITOR

The heat quantity recording and the calculation of the energy consumed are carried out separately for each individual heat pump operating in parallel mode.

Heat quantity and energy used must be queried at each individual heat pump operating in parallel mode.

→ page 21, "Query energy monitor"

## SELECT PROGRAM AREA

The program area "Parallel mode" must be set by authorised service personnel during commissioning.

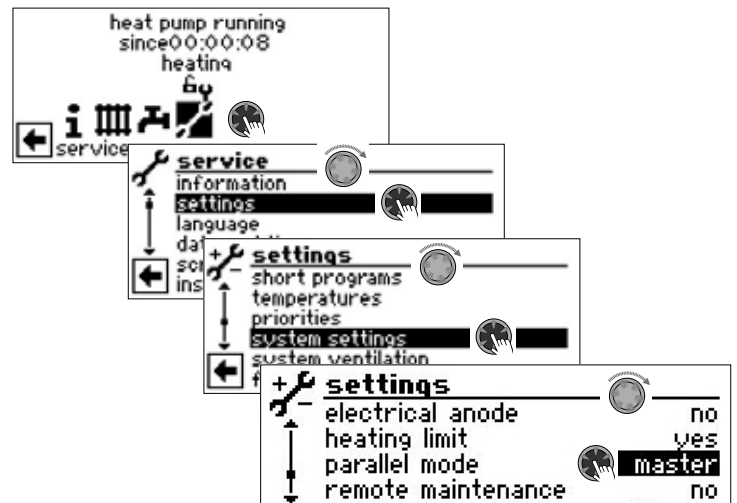

Parallel mode

Only one of the interconnected heat pumps may be set as "Master".  
 For all other heat pumps, "Slave" must be set here.

Save the settings.



Is the heatpump defined as "Master" you can see this symbol in the navigation screen :



Is the heatpump defined as "Slave" you can see this symbol in the navigation screen :

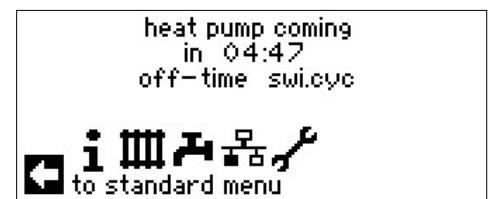



## IP-ADRESS

If the heat pumps are connected via a router, the DHCP option "off" must be set on each heat pump..

→ Part 1 of the controller manual, program area "Service", section, "Control Panel / Web server"

The network addresses of the heat pumps must be entered manually. The IP addresses of the heat pumps must be different, but the data on subnet mask, broadcast, gateway, DNS1 and DNS2 must match.

## Set the network addresses

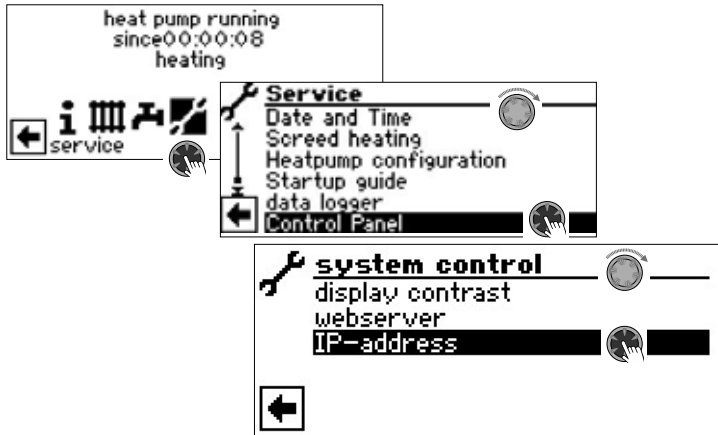

### Example

Network setting for the master:

→ IP-address	
← IP	192.168.002.010
subnetmask	255.255.255.000
broadcast	192.168.002.255
gateway	192.168.002.001
DNS 1	192.168.002.001
← DNS 2	192.168.001.001

IP	IP-Adress of the master
Subntzmsk.	IP-Adress must be the same for all heat pumps
Broadcast	IP-Adress must be the same for all heat pumps
Gateway	IP-Adress must be the same for all heat pumps
DNS 1	IP-Adress must be the same for all heat pumps
DNS 2	IP-Adress must be the same for all heat pumps

Scroll all the way down,  
save the settings.



Network setting for the slave 1:

→ IP-address	
← IP	192.168.002.011
subnetmask	255.255.255.000
broadcast	192.168.002.255
gateway	192.168.002.001
DNS 1	192.168.002.001
← DNS 2	192.168.001.001

IP

IP address of the slave 1. The first three number blocks (here: 192.168.002) must correspond to the first three number blocks of the master. The fourth number block (here: 011) must differ from heat pump to heat pump. In a system with 2 or 3 heat pump slaves, the last three digits must also be set as unique numbers (different from one another)

i

### NOTE

The first three number blocks of the IP addresses must always be identical (as in the illustrated example: 192.168.002). The fourth number block must always differ from heat pump to heat pump (in the illustrated example: 010 for the master, 011 for the slave 1).

Scroll all the way down,  
save the settings.



## EXTERNAL RETURN FLOW SENSOR

One parallel mode usually has one single buffer tank for all heat pumps. In this case, the external return flow sensor must be installed in this buffer tank and connected to the master.

→ page 10, "External return flow sensor"

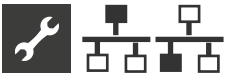

## SETTING ON THE MASTER

### NETWORK

#### Search for Slaves

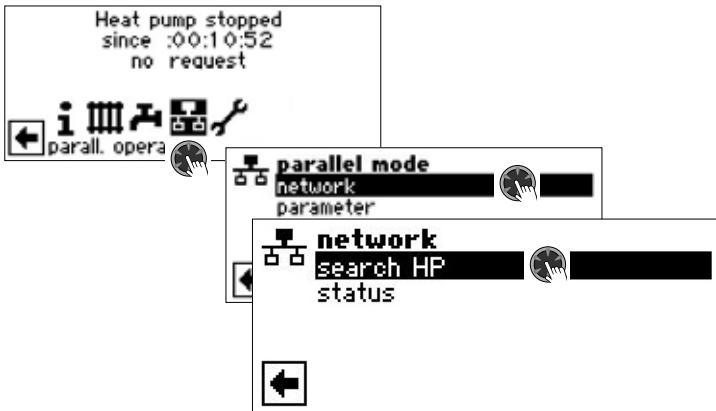

search HP

Selecting "search HP" will initiate a search throughout the network.

#### **NOTE**

A successful search requires that all heat pumps that are supposed to work in parallel be switched on and that the network data of all heat pumps are set correctly.

As soon as the search is finished the IP addresses of all heat pumps present in the network and permitted for parallel mode are displayed.

#### Example



- 192.168.2.10      IP address heat pump = master
- 192.168.2.11      IP address heat pump 2
- 192.168.2.12      IP address heat pump 3
- 192.168.2.13      IP address heat pump 4

Select a maximum of 3 heat pumps (= IP addresses) that are to work as slaves in parallel mode.

Save the settings.



#### Status of the master

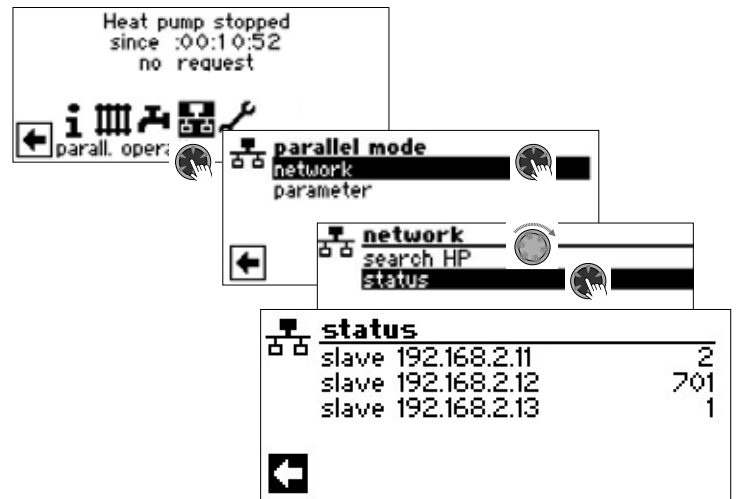

status

This menu shows which information the master receives from the individual slave heat pumps

Possible values

- 0    no compressor activ
- 1    one compressors activ
- 2    two compressors aktiv
- 7xx error: operation of the slave

→ page 50, "Error Diagnosis / Error messages"

### SET PARAMETERS

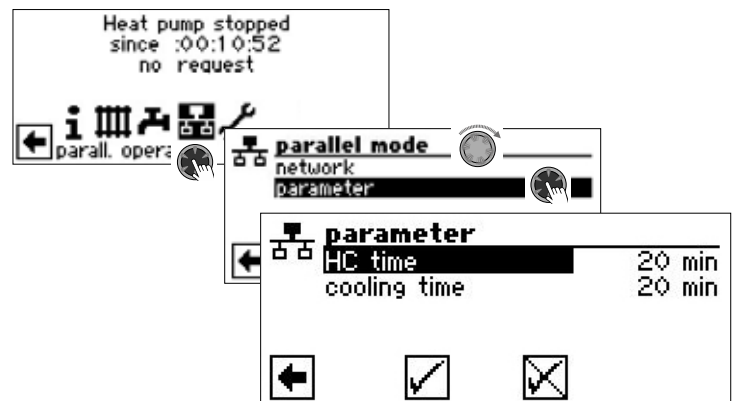

HC time

means heating control time. This time defines at what interval the heating is supposed to switch to the next higher / lower bivalent level (compressor switch-on/shut-off).

This value should not be set to less than 10 minutes for 2 heat pumps.

If you set 20 min., it would take 20 minutes until the second compressor stage would be energised following the first compressor stage if a corresponding request is received. The request is determined by the setpoint and actual return temperature of the master. To see how much of the HC time has expired, refer to Information > Elapsed times.



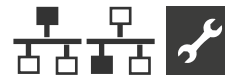

## HysParallel

applies only to LWP  
 In addition to the heating regulator hysteresis there is also a parallel hysteresis for parallel connections of LWP heat pumps. This hysteresis must always be greater than the heating regulator hysteresis of the master heat pump. The purpose of this second hysteresis setting is to cut in half the "HC time" that will expire before the next switch-on/switch-off if this hysteresis is exceeded. This allows for a quicker control response if the difference between setpoint and actual temperature is too great

## cooling time

means cooling controller time. This time defines at what interval the heating is supposed to switch to the next higher / lower bivalent level (compressor switch-on/shut-off). This value should not be set to less than 10 minutes for 2 heat pumps. If you set 20 min., it would take 20 minutes until the second compressor stage would be energised following the first compressor stage if a corresponding request is received. The request is determined by the temperatures of the master.

Save the settings.



## SERVICE MENU

Only for Hybrox heat pumps and with data access "Installer" or "Service"

For service purposes, the compressors of the individual heat pumps of the parallel mode can be selectively switched on or off at the master. In addition, a setpoint of the frequency can be set for all compressors.

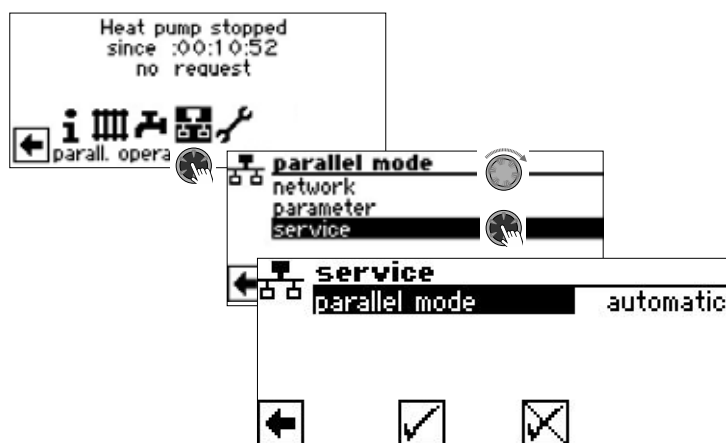

## parallel mode

automatic = Standard setting for regular operation  
 Manual = Setting for service purposes only

service	
parallel mode	manual
freq. targ. value	6000 RPM
master	on
slave 192.168.2.11	on
slave 192.168.2.12	on
slave 192.168.2.13	on

## freq. targ. value

Setpoint of the frequency with which the compressors of the heat pumps are to run in parallel mode

## master

Menu item by which the compressor of the master can be switched on or off manually

## slave IP

Menu item by which the compressor of slave 1, 2 or 3 can be switched on or off manually



## NOTE

The individual slaves are only listed one after the other after a delay of 30 seconds.

Scroll all the way down, save the settings.



In manual parallel mode, domestic hot water preparation and / or swimming pool heating are deactivated on all slaves.

After the service work has been done, the parallel mode should be reset to "Automatic" and the "Automatic" setting should be saved in order to guarantee the regular operation.

An automatic reset of the manual parallel mode only takes place after changing the data access (reset to "User") or after a restart of the heating and heat pump control (power interruption).



## Error Diagnosis / Error messages

No.	Display	Description	Remedy
701	Error low pressure. Please call AS	Low pressure pressostat or low-pressure sensor in the cooling circle has responded (L/W) or for longer than 20 seconds (S/W).	Check HP for leakage, switching point pressure state, defrosting and T-outd.min.
702	Low pressure stop Reset autom.	Only possible for L/W devices: Low pressure in the cooling circle has responded. After some time, automated HP restart.	Check HP for leakage, switching point pressure state, defrosting and T-outd.min.
703	Antifreeze Please call installer	Only possible for L/W devices: If the heat pump is running and the temperature in flow is < 5 °C, antifreeze is detected.	Check HP power, defrost valve and heating system.
704	Error hot gas Reset in hh:mm	Maximum temperature in the hot gas cooling circle exceeded. Automatic HP restart after hh:mm.	Check coolant quantity, evaporation, overheating flow, return and HS-min.
705	Motor protection VEN Please call installer	Only possible for L/W devices: Motor protection has responded.	Check set value and ventilator / BCP.
706	Motor protection BCP Please call installer	Option only possible for S/W- or W/W devices Motor protection of the brine or well water circulating pump or the compressor has responded.	Check set values, compressor, BOS.
707	Coding of HP Please call installer	Break or short-circuit of the coding bridge in HP after the first switch-on.	Coding resistance in HP, check plug and connection line.
708	Return sensor Please call installer	Break or short-circuit in the return sensor.	Check return sensor, plug and connection line.
709	Flow sensor Please call installer	Break or short-circuit in the flow sensor No fault shutdown for S/W- or W/W devices.	Check flow sensor, plug and connection line.
710	Hot gas sensor Please call installer	Break or short-circuit in the hot gas sensor of the cooling circle.	Check hot gas sensor, plug and connection line.
711	External temp. sensor Please call installer	Break or short-circuit in the external temperature sensor No fault shutdown. Fixed value to -5 °C.	Check external temperature sensor, plug and connection line.
712	Domestic hot water sensor. Please call installer	Break or short-circuit in the domestic hot water sensor No fault shutdown.	Check domestic hot water sensor, plug and connection line.
713	HS-on sensor Please call installer	Break or short-circuit in the heat source sensor (inlet).	Check heat source sensor, plug and connection line.
714	Hot gas SW Reset in hh:mm	Check thermal application limit of the HP. Domestic hot water off for hh:mm. Fault only triggers if the compressor is running.	Check flow of domestic hot water, heat exchanger, domestic hot water temperature and circulation pump.
715	High-pressure switch-off Reset autom.	High pressure in the cooling circle has responded. After some time, automated HP restart.	Check flow of HW, overflows, temperature and condensation.
716	High-pressure fault Please call installer	High pressure pressostat in the cooling circle has responded several times.	Check flow of HW, overflows, temperature and condensation.
717	Flow HS Please call installer	Flow switch for W/W devices has responded during the pre-rinsing time or operation.	Check flow, switching point for DFS, filter, air clearance.
718	Max. outside temp. Reset autom. in hh:mm	Only possible for L/W devices: Outside temperature has exceeded permissible maximum value. Automatic HP restart after hh:mm.	Check outside temperature and set value.
719	Min. outside temp. Reset autom. in hh:mm	Only possible for L/W devices: Outside temperature has fallen below the permissible minimum value. Automatic HP restart after hh:mm.	Check outside temperature and set value.
720	HS temperature Reset autom. in hh:mm	Option only possible for S/W- or W/W devices Temperature at evaporation outlet has fallen below the safety value on the HS side several times. Automatic HP restart after hh:mm.	Check flow, filter, air clearance, temperature.
721	Low-pressure switch-off Reset autom.	Low pressure pressostat or low-pressure sensor in the cooling circle has responded. After some time, automated HP restart (S/W and W/W).	Check switching point of the pressostat, flow on HS side.
722	Tempdiff HW Please call installer	Temperature spread in the heating mode is negative (=erroneous).	Check function and location of the flow and return sensor.
723	Tempdiff SW Please call installer	Temperature spread in the domestic hot water mode is negative (=erroneous).	Check function and location of the flow and return sensor.



No.	Display	Description	Remedy
724	Tempdiff defrosting Please call installer	Temperature spread in the heating circle is > 15 K during defrosting (=danger of frost).	Check function and location of the flow and return sensor, HCP capacity, overflows and heating circles.
725	System error DHW Please call installer	Domestic hot water faulty, desired tank temperature is fallen below substantially.	Check circulating pump DHW, tank filling, shutoff move and 3-way valve. Ventilate hot water and SW.
726	Sensor mixing circ 1 Please call installer	Break or short-circuit in the mixing circle sensor.	Check mixing circle sensor, plug and connection line.
727	Brine pressure Please call installer	Brine pressure pressostat has responded during the pre-rinsing time or during operation.	Check brine pressure and brine pressure pressostat.
728	Sensor HS Off Please call installer	Break or short-circuit in the heat source sensor at the HS outlet.	Check heat source sensor, plug and connection line.
729	Rotating field error Please call installer	Compressor without power after switching on.	Check rotating field and compressor.
730	Screed heating error Please call installer	The screed heating program could not reach an FL temperature level in the specified time interval. Screed heating program continues running.	The screed heating program could not reach an FL temperature level in the specified time interval. Screed heating program continues running.
731	Timeout TDI	The temperature required for thermal disinfection could not be reached within the set switching times.	
732	Cooling fault Please call installer	The hot water temperature of 16 °C has been fallen short of several times.	Check mixer and heating circulation pump.
733	Anode fault Please call installer	Fault input of the impressed current anode has responded.	Check connection line between anode and potentio stat. Fill SW tank.
734	Anode fault Please call installer	Error 733 present for more than two weeks and domestic hot water is locked.	Acknowledge error in order to release domestic hot water preparation again. Rectify 733.
735	Error Ext. En Please call installer	Only possible with installed expansion board: Break or short-circuit in the sensor "External energy source".	Check sensor "External energy source", plug and connection line.
736	Error solar collector Please call installer	Only possible with installed expansion board: Break or short-circuit in the "solar collector" sensor.	Check "solar tank" sensor, plug and connection line.
737	Error solar tank Please call installer	Only possible with installed expansion board: Break or short-circuit in the "solar tank" sensor.	Check "solar tank" sensor, plug and connection line.
738	Error mixing circle 2 Please call installer	Only possible with installed expansion board: Break or short-circuit in the "mixing circle 2" sensor.	Check "mixing circle 2" sensor, plug and connection line.
739	Error mixing circle 3 Please call installer	Only possible with installed expansion board: Break or short-circuit in the "mixing circle 3" sensor.	Check "mixing circle 3" sensor, plug and connection line.
750	Return sensor external Please call installer	Break or short-circuit in the external return sensor.	Check external return sensor, plug and connection line.
751	Phase monitoring fault	Phase-sequence relay has responded.	Check rotary field and phase-sequence relay.
752	Flow error	Phase-sequence relay or flow switch has responded.	see errors No. 751 and No. 717.
755	Lost connection to slave Please call installer	A slave has not responded for more than 5 minutes.	Check network connection, switch, and IP addresses. Perform HP search if necessary.
756	Lost connection to master Please call installer	A master has not responded for more than 5 minutes.	Check network connection, switch, and IP addresses. Perform HP search if necessary.
757	Low-pressure fault in W/W-appliance	Low-pressure pressostat in the W/W-appliance has triggered either repeatedly or for more than 20 seconds.	If this malfunction occurs three times, the installation can only be cleared again by authorised service personnel!
758	Defrosting malfunction	Five times in a row, defrosting has either lasted longer than 10 minutes or was terminated with a feed temperature of < 10 °C.	Check flow rate. Check flow sensor.
759	TDI message	Unable to correctly carry out thermal disinfection 5 times in succession.	Check setting of additional heating generator and safety temperature limiter.
760	Defrosting fault	Defrosting ended 5 times in succession by maximum time (strong wind impinges on evaporator) .	Protect the fan and evaporator from strong wind.
761	LIN timeout	LIN connection interrupted	Check cable/contact.



No.	Display	Description	Remedy
762	Sensor compressor intake	Tü sensor error (compressor intake).	Check sensor, replace if necessary.
763	Sensor evaporator intake	Tü1 sensor error (evaporator intake).	Check sensor, replace if necessary.
764	Sensor compressor heater	Sensor error compressor heater.	Check sensor, replace if necessary.
765	Suction gas Overheating (SSH)	Suction gas overheating longer than 5 minutes above / below 2K. Reset autom. after 5 minutes or manually.	If the error occurs several times, the refrigerant circuit is permanently blocked. Please call AS
766	compressor's functional range	Operation for 5 minutes outside the compressor's functional range. Reset if TRLeXT > 1752°C or after max. 2 h	If there is an ZWE, switch on the ZWE for heating.
767	STB E-Rod	STB of the heating element has been activated.	Check the heating element and press the fuse back in.
768	Flow monitoring	Insufficient flow in defrost cycle.	Check hydraulics, check pump, check flow.
769	Pump control	No valid flow signal from the circulating pump. Reset autom.	Check the wiring of the load and control cables of the circulation pump. Check the circulating pump. Remedy fault.
770	Low overheat	Overheating lies below the limit value for a lengthy period.	Check the temperature sensor, pressure sensor and expansion valve.
771	High overheat	Overheating lies below the limit value for a lengthy period.	Check the temperature sensor, pressure sensor, fill quantity and expansion valve.
775	SEC EVI valve	Electronic expansion valve is no longer recognised by the control in the EVI circuit	Check the expansion valve, connection cable and if applicable the SEC board
776	limit of application-CP	Compressor operates outside its use limits for a lengthy period.	Check the thermodynamics.
777	Expansion valve	Electronic expansion valve is defective.	Check the expansion valve, connection cable and if applicable the SEC board.
778	Low pressure sensor	Low-pressure sensor is defective.	Check the sensor, connector and connection cable.
779	High pressure sensor	High-pressure sensor is defective.	Check the sensor, connector and connection cable.
780	EVI sensor	EVI sensor is defective.	Check the sensor, connector and connection cable.
781	Liquid temp. sensor before EXV	Liquid temperature sensor upstream of the ex-valve is defective.	Check the sensor, connector and connection cable.
782	Suction gas EVI temp. sensor	Suction gas EVI temperature sensor is defective.	Check the sensor, connector and connection cable.
783	Communication SEC board – Inverter	Connection between the SEC board and the inverter is disrupted.	Check the connection cable, interference suppression capacitors and wiring.
784	VSS lockdown	Inverter is blocked.	Disconnect the complete system from the power supply for 2 minutes. If it occurs again, check the inverter and compressor.
785	SEC-Board defective	Error found in the SEC board.	Replace the SEC board.
786	Communication SEC board – Inverter	Connection between SEC board and HZ/IO is disrupted by the SEC board.	Check the HZ/IO – SEC board wiring.
787	VD alert	Compressor signals faults.	Acknowledge fault. If an error occurs repeatedly, phone the authorised service personnel (customer service).
788	Major VSS fault	Fault in the inverter.	Check the inverter.
789	LIN/Encoding not found	Control unit unable to find coding. Either the LIN connection is interrupted or the coding resistor is not detected.	Check the connection cable LIN / coding resistor.
790	Major VSS fault	Fault in the power supply of the inverter / compressor.	Check the wiring, inverter and compressor.
791	ModBus connection lost Inverter	The control panel has no ModBus communication with the inverter for at least 10 seconds or 10 communication packets to the inverter were lost. Reset autom..	Check the Modbus wiring of inverter.
792	LIN-connection lost	Unable to find a master board or any configuration.	Check the coding connector on the LIN board(s).



No.	Display	Description	Remedy
793	Inverter Temperature	Temperature sensor fault in the inverter. Internal inverter temperature too high at least 5x within 24 h.	Fault acknowledges itself.
794	Overvoltage	Overvoltage on inverter.	Check the inverter voltage supply.
795	Undervoltage	Undervoltage on inverter.	Check the inverter voltage supply.
796	Safety switch off	Safety Input was triggered. Manual reset required. Case 1: Inverter malfunction.  Case 2: High-pressure pressostats in refrigerating circuit have triggered  Case 3: Only LWDV / Hybrox malfunction message caused by voltage fluctuations exceeding the valid standard..	Case 1: Check inverter. Remedy fault. Case 2: Check HW throughflow, overflow, flow temperature sensor and high-pressure sensor. Remedy fault. Case 3: It must be turned off and resecured manually
797	MLRH is not supported	Heating rod regulating is not supported.	–
798	ModBus connection lost Fan	No ModBus communication with the fan for at least 10 seconds. Reset autom..	Check ModBus – Fan wiring
799	ModBus connection lost ASB	No ModBus communication with the ASB board for at least 10 seconds. Reset autom..	Check ModBus – ASB board wiring
800	Desuperheater-error	Shutdown is triggered when desuperheater temperature $\geq 80^\circ\text{C}$ . Device is switched off and D0_Pause is written in shutdowns. Device is released again for operation after 2 hours. If the shutdown occurs 5 times within 24 hours, error 800 is written to the fault memory.	Remove energy from desuperheater memory. The machine can be restarted as soon as the temperature falls $< 80^\circ\text{C}$ .
801	HP offline	The heating and heat pump controll does not have an Internet connection has no internet connection	Establish internet connection.
802	Temperature electrical switch box	Shutdown will be triggered when temperature in the electrical switch box $\geq 80^\circ\text{C}$ . If the temperature falls below $70^\circ\text{C}$ , then the heat pump will start up again. Reset autom..	Check fan for correct function. Check connection cable. Check sensor. Check electrical control box openings for blockages.
803	Temperature electrical switch box Blockage	Error 802 tripped 3 times within 24 hours. Manual reset required. If the temperature in the electrical switch box is still $\geq 80^\circ\text{C}$ , the error will be triggered again immediately.	Check fan for correct function. Check connection cable. Check sensor. Check electrical control box openings for blockages.
804	Sensor temperature electrical switch box	Sensor error electrical switch box temperature.	Check sensor.
805	Sensor desuperheater	Sensor error desuperheater temperature.	Setting in the menu “FlexConfig - Out2” is set to “Enth” although this is not required. Deselect “Enth” Check sensor.
806	ModBus SEC	The SEC-board has no ModBus communication for at least 10 seconds or query has failed 10 times in a row. Reset autom..	Check ModBus – SEC board wiring.
807	Lost ModBus communication	All possible ModBus communication faults with unit components for the respective unit are present simultaneously for at least 10 seconds. Reset autom..	Check ModBus interface on the control unit, connection cable to ModBus distributor and ModBus distributor itself. Check Modbus wiring.
808	Hardware not supported	Software version of the heating and heat pump controller is incompatible with installed ASB hardware.	Carry out software update
809	Overheating hot gas (DSH)	DSH_break was triggered 3 times within 24 h. Reset autom. after 5 minutes or manually.	If the error occurs several times, please call AS
810	version parallel mode	The heating and heat pump controls connected in parallel operation have different software versions.	Update the software versions of the heat pumps connected for parallel mode to an identical version. Reset manually.
811	Check condensate pan Please call installer	COPS float switch has tripped.	Remove water from condensate overflow protection tray. Clean the condensate pan in the heat pump including the drain. Reset manually.





No.	Display	Description	Remedy
812	Maximum flow rate	Maximum permissible flow rate of the circulation pump was exceeded 5 times within 24 h	Please call installer
813	Inverter not compatible Please call installer	The inverter of the heat pump is not compatible. The compressor of the heat pump is blocked. Only operation with ZWE is possible.	Replace the inverter. Reset manually.

## ACKNOWLEDGING A FAULT

If a fault occurs and an error message appears in the screen, then:

1. Notice error number.
2. Acknowledge error message by pressing the “rotary pushbutton” (for 7 seconds).  
The screen changes from the error message to the navigation screen.
3. If this error message occurs again, contact the installer or authorised service personnel (= customer service), if the error message prompted you to do this. Communicate error number and arrange further procedure.

## FLASHING CODES ON CONTROLLER BOARD

Green LED flashes every second	everything ok
Red LED flashes briefly for short	Data being received over LIN bus
Green and red LED light up	The board can receive a software update

During the software update the green LED is lit and the red one flickers quickly

# Technical Data

## INSTALLATION

Only in frost-free, dry and weatherproof rooms.

Ambient temperature: 0 °C – 35 °C

Electrical connection: 230 V AC, 18 VA, 0.1 A  
(max. power consumption regulator without any appliances connected)

Fuse: 1.6 A (transformer)

## OUTPUTS

Relay contacts: 8 A / 230 V,

Fuse: 6.3 A (for all relay outputs)

In total consumers up to 1,450 VA can be connected to the outputs

## INPUTS

Optocoupler: 230 V

Sensor inputs: NTC sensor 2.2 kΩ / 25 °C

## CONNECTIONS

Control line: 12-pole, outputs 230 V

Sensor line: 12-pole, low voltage

Plug-in terminals: 1-pole, screw terminals

## INTERFACES

USB: USB version 2.0 (USB 2.0)

Host, A plug (only for a USB stick!)

Ethernet: 1 x 10 Base-T / 100 Base-TX  
(RJ-45, plug, bent)

## PROTECTION CLASS

Protection class IP 20

## TEMPERATURE SENSOR CHARACTERISTIC CURVE

t / °C	R / kΩ
-25	21.291
-20	16.425
-15	12.773
-10	10.010
-5	7.903
+/-0	6.284
+5	5.030
+10	4.053
+15	3.287
+20	2.681
+25	2.200
+30	1.815
+35	1.505
+40	1.255
+45	1.051
+50	0.885
+55	0.748
+60	0.636
+65	0.542
+70	0.464
+75	0.399
+80	0.345
+85	0.299
+90	0.260
+95	0.227
+100	0.198
+105	0.174
+110	0.153
+115	0.136
+120	0.120
+125	0.106
+130	0.095
+135	0.085
+140	0.076



## SENSOR MEASURING RANGE

Type of sensor	Measuring range	Autom. value in case of sensor defect
PEX	-40°C to 40°C	-
TA	-50°C to 90°C	-5 °C
TBW	-45°C to 155°C	75 °C
TFB1	-20°C to 150°C	75 °C
TRL ext	-40°C to 40°C	5 °C
TVL	0°C to 100°C	5 °C
TVL2/TEH	0°C to 100°C	5 °C
TRL	0°C to 100°C	5 °C

Extension board		
TSS	-20°C to 140°C	150°C
TSK	-20°C to 140°C	150°C or 5°C
TB2	0°C to 100°C	75°C
TB3	0°C to 100°C	75°C
TEE	0°C to 100°C	5°C



























## OVERVIEW: DEFROST CYCLE, AIR DEFROST, FLOW MAX

	Defrost cycle	Air defrost from / end	Flow Max		
			flow Max.	min. AT flow max.	low limit of applic.
LW 160H(A)V	45	-	65	-15	60
LW 161H(A)V	variable	-	65	-15	60
Paros 4	variable	-	65	2	45
LWV 82R1/3	variable	-	60	-5	45
LWV 122R3	variable	-	60	-5	45
LWAV 82R1/3	variable	-	60	-5	45
LWAV 122R3	variable	-	60	-5	45
LWAV+ 82R1/3	variable	-	60	-5	45
LWAV+ 122R3	variable	-	60	-5	45
LWCV 82R1/3	variable	-	60	-5	45
LWCV 122R3	variable	-	60	-5	45
LWP 450AR3	60	-	65	-10	60
LWDV	variable	-	70	-7	60
Hybrox 5	variable	-	70	-7	60
Hybrox 8	variable	-	70	-7	60

# System setting during commissioning

## NOTE

The software automatically detects the connected heat pump type. Parameters that are not relevant for the system situation or for the heat pump type are hidden from view. For this reason, some of the parameters contained in this overview may not appear in the display of your heating and heat pump controller.

Parameter	Factory setting	Adjustment during commissioning *)	Value range (adjustable steps)	Access
<b>Program section "Cooling"</b>				
release OT	20 °C	°C	15 °C – 35 °C (‡1) LWP & S/W: 10 °C – 35 °C (‡1)	 User
OT diff. MC1	5.0 K	K	1.0 K – 10 K (‡0.5)	 User
target temp. MC1	20 °C	°C	18 °C – 25 °C (‡1) integration with "Sep.tank": 5 °C – 25 °C (‡1)	 User
hysteresis CC	L/W: 3.0 K S/W: 2.0 K		1 K – 5.0 K (‡0.5)	 Installer
Targ. return cooling	20 °C	K	13 °C – 25 °C (‡0.5)	 User
OT – excess	12 h	h	0 h – 12 h (‡0.5)	 User
OT – undercut	12 h	h	0 h – 12 h (‡0.5)	 User
RT-exceed	12 h	h	0 h – 12 h (‡0.5)	 User
<b>Temperatures</b>				
return temp. limit.	50 °C	°C	35 °C – 70 °C (‡1)	 Installer
hysteresis heating	2.0 K	K	0.5 K – 6.0 K (‡0.5)	 Installer
hysteresis DHW	2.0 K	K	1.0 K – 30.0 K (‡1)	 Installer
max. return increase	7.0 K	K	1.0 K – 10.0 K (‡1)	 AS
Release 2.VD	5 °C	°C	-20 °C – 30 °C (‡1)	 Installer
Release ZWE	L/W: -2 °C S/W & W/W: -16 °C	°C	-20 °C – 20 °C (‡1)	 Installer
temp. air defrost.	7 °C	°C	6 °C – 20 °C (‡1)	 AS
TDI target temp.	65 °C	°C	50 °C – 70 °C (‡1)	 User
Flow temp. 2VD DHW	50 °C	°C	10 °C – 70 °C (‡1)	 Installer
max. outdoor temp.	35 °C LWV, LWP: 40 °C LWDV: 45 °C	°C	20 °C – 45 °C (‡1)	 AS
min. outdoor temp.	-20 °C	°C	-20 °C – 10 °C (‡1)	 Installer
min. heat source temp.	Brine: -9 °C Wat./Brine: 1 °C Wat./Wat.: 3 °C LWP: -20 °C	°C	-20 °C – 20 °C (‡1)	 AS
min HS in flow max	0 °C	°C	-5 °C – 10 °C (‡1)	 AS
max. hot gas temp.	LWP: 140 °C S/WV: 115 °C S/W: 130 °C	°C	100 °C – 150 °C (‡1)	 Factory
temp.air defrost stop	LWP: 6 °C	°C	2 °C – 10 °C (‡1)	 AS
lowering to	-20 °C	°C	-20 °C – 10 °C (‡1)	 User
max. flow temp.	L/W: device-dependent LWDV: 70 °C LWP: 65 °C S/W & W/W: 64 °C	°C	35 °C – 75 °C (‡1)	 AS
min. OT flow max.	-7 °C L/W: device-dependent	°C	-20 °C – 5 °C (‡1)	 Installer

\*) Please enter the adjusted values. Mark not applicable with — .



Parameter	Factory setting	Adjustment during commissioning *)	Value range (adjustable steps)	Access
flow operation limit	L/W: device-dependent LWDV: 62 °C S/W & W/W: 52 °C	°C	35 °C – 75 °C (‡1)	🔒 AS
hysteresis CC	L/W: 3.0 K S/W: 2.0 K		1 K – 5.0 K (‡0.5)	🔧 Installer
DHW temp. max.	65 °C	°C	30 °C – 65 °C (‡0.5)	🔧 Installer
min return targ.temp	15 °C	°C	15 °C – 30 °C (‡0.5)	👤 User
Defrost end temp.	45 °C		35 °C – 45 °C (‡1) LW161HAV / LW161HV: 35 °C – 50 °C (‡1)	🔒 AS
minimal flow mc 1	20 °C	°C	20 °C – 40 °C (‡1)	🔧 Installer
maximum flow mc 1	45 °C	°C	25 °C – 75 °C (‡1)	🔧 Installer
reduct. 2 VD hyster.	4.0 K	K	2 – 6 (‡1)	🔧 Installer
desuperheater max.	65 °C	°C	30 °C – 75 °C (‡1)	🔧 Installer
min. flow cooling	18 °C	°C	device-dependent: 7 °C – 25 °C (‡1) or 18 °C – 25 °C (‡1)	🔧 Installer
min. flow cooling 2VD	10 °C	°C	7 °C – 20 °C (‡1)	🔧 Installer
night lowering HC	0 °C	°C	-15 °C – 10 °C (‡0.5)	👤 User
night lowering MC1	0 °C	°C	-15 °C – 10 °C (‡0.5)	👤 User
<b>System settings</b>				
EVU cut-off	no ZWE		no ZWE • with ZWE	🔧 Installer
remote control	No		No • RBE • Smart	👤 User
Integration	series		series • parallel	🔧 Installer
Mixing circuit 1	No		no • charge • discharge • cool • heat+cool	🔧 Installer
Error	no ZWE		no ZWE • Heating • DHW • with ZWE	🔧 Installer
DHW 1	sensor		sensor • Thermostat	👤 User
DHW 2	ZIP		ZIP • BLP	🔧 Installer
DHW 3	with ZUP		no ZUP • with ZUP	🔧 Installer
DHW 4	targ. value		targ. value • Max	🏭 Factory
DHW 5	device-dependent		no HUP • with HUP • par HUP	🔧 Installer
DHW+HP max	0 h		0 h – 8 h (‡0.5)	👤 User
Defrost cycle max	45 min		45 • 60 • 75 • 90 • 120 • 180 • 240 min	🔧 Installer
air defrost	No		No • Yes	🔒 AS
air defrost max	15 min		5 min – 30 min (‡1)	🔒 AS
pump optimization	Yes		No • Yes	👤 User
Access	AS		Installer • AS	🔒 AS
brine pres/flow	device-dependent		No • flow rate • brine pres • pow.suppl. • pow.+flow	🔒 AS
monitoring VD	On		Off • On	🔒 AS
control HC	OT regul		OT regul • fix temp	🔧 Installer
control MC1	OT regul		OT regul • fix temp	🔧 Installer
cooling	fix temp		OT regul • fix temp	👤 User
screed heating	with mixer		no mixer • with mixer	👤 User
electrical anode	device-dependent		No • Yes	🔒 AS
heating limit	Yes		No • Yes	👤 User
parallel mode	No		No • Slave • Master	🔧 Installer
remote maintenance	No		No • Yes	👤 User
pump optim. time	180 min		5 – 180 min (‡5)	👤 User

\*) Please enter the adjusted values. Mark not applicable with — .





Parameter	Factory setting	Adjustment during commissioning *)	Value range (adjustable steps)	Access
flow VBO	1 min		1 – 5 min (‡1)	🔧 Installer
defrost cycle min	45 min		45 • 60 • 90 • 120 • 180 • 240 • 300	🏭 Factory
reduction 2 VD	20 min		5 – 20 min (‡1)	🔧 Installer
TDI Message	Yes		No • Yes	🔧 Installer
heat source	No		No • brine • wat./brine • water.	🔧 AS
release ZWE Heat	60 min		20 min - 360 min (‡5)	🔧 Installer
release ZWE DHW	No		0 min - 120 min (‡5)	🔧 Installer
aux. heat. hot water	No		No • Yes	👤 User
DHW postheat. max	–		1 h – 10 h (‡0.5)	🔧 Installer
high pressure limit	device-dependent		device-dependent	🏭 Factory
low pressure limit	device-dependent		device-dependent	🏭 Factory
capacity ZWE	device-dependent		0.5 kW – 9 kW (‡0.5)	👤 User
smart grid	No		No • Yes	🔧 Installer
control MC1	fast		fast • medium • slow	👤 User
compressor heating	Yes		No • Yes	🔧 Installer
Cooling	no ZUP		with ZUP • no ZUP	🔧 Installer

### Efficiency pump

Heat distrib. sys	RAD		RAD • UFH	🔧 Installer
control heating	Auto		Auto • Manual	🔧 Installer
output heat. nom.	100 %		1 % – 100 % (‡1)	🔧 Installer
output heat. Min.	100 %		1 % – 100 % (‡1)	🔧 Installer
Output heat. max.	100 %		50 % – 100 % (‡1)	🔧 Installer
Control DHW	Auto		Auto • Manual	🔧 Installer
output DHW.	100 %		1 % – 100 % (‡1)	🔧 Installer
output dhw max	100 %		50 % – 100 % (‡1)	🔧 Installer
output cooling	100 %		1 % – 100 % (‡1)	🔧 Installer
control VBO	Auto		Auto • Manual	🔧 Installer
output VBO	100 %		1 % – 100 % (‡1)	🔧 Installer
output VBO (cooling)	100 %		1 % – 100 % (‡1)	🔧 Installer
dT cooling	5 K		1 K – 5 K (‡0.1)	🔧 Installer
Set bypass valve	No		No • Yes	👤 User

### Additional heating generator

Add. heat. gen. 1				
Type	No		No • El.heater • Boiler • Therme	🔧 Installer
Function	heat+DHW		No • heat+DHW • Heating	🔧 Installer
Position	Integrated		--- • Integrated • Tank	🔧 Installer
Outlet	installation-dependent		--- • (output contact)	🔧 Installer
capacity	device-dependent		0.5 kW – 27.0 kW (‡0,5)	🔧 Installer
Add. heat. gen. 2				
Type	No		No • El.heater	🔧 Installer
Function	No		No • Heating • Domestic hot water	🔧 Installer
Position	---		--- • Tank	🔧 Installer
Outlet	---		--- • (output contact)	🔧 Installer
capacity	device-dependent		0.5 kW – 27.0 kW (‡0,5)	🔧 Installer

\*) Please enter the adjusted values. Mark not applicable with — .



Parameter	Factory setting	Adjustment during commissioning *)	Value range (adjustable steps)	Access
<b>Inverter</b>				
freq. limit start	0 Hz		0 Hz – 120 Hz (‡1)	🔑 Installer
frequency limit stop	0 Hz		0 Hz – 120 Hz (‡1)	🔑 Installer
Freq. DHW	Auto		Auto • ... Hz 20 Hz – 120 Hz (‡1)	🔑 AS
DHW	normal		normal • luxury	🔑 User
<b>FlexConfig</b>				
OUT 2	ZIP		ZIP • KS • BLP • Enth • ---	🔑 Installer
OUT 3	ZWE 2		ZWE 2 • FP1 • ---	🔑 Installer
<b>Silent Mode</b>				
Silent Mode	No		Yes • No	🔑 Installer
<b>Pump flow</b>				
Pump flow lead time VBO	1 min		1 – 5 min (‡1)	🔑 Installer
Pump flow lead time ZUP	60 s		60 – 300 s (‡5)	🔑 Installer
<b>Smart</b>				
Smart Home ID	–		1 – 4 (‡1)	🔑 User
Heating circuit	No		No • Yes	🔑 User
range +	0 K		0 K – 5 K (‡1)	🔑 User
range –	0 K		0 K – 5 K (‡1)	🔑 User
mixing circ 1	No		No • Yes	🔑 User
range +	0 K		0 K – 5 K (‡1)	🔑 User
range –	0 K		0 K – 5 K (‡1)	🔑 User
DHW	No		No • Yes	🔑 User
intelligent defrost	No		No • Yes	🔑 Installer
<b>Smart Grid</b>				
Decrease Heating	-2 K		-0.5 K – -25 K (‡0.5)	🔑 Installer
Increase heating	2 K		0.5 K – 5 K (‡0.5)	🔑 Installer
Increase DHW	2 K		0.5 K – 10 K (‡0.5)	🔑 Installer
<b>Settings parallel mode</b>				
IP-Adresses				🔑 User
Master				🔑 User
Slave 1	–		–	🔑 User
Slave 2	–		–	🔑 User
Slave 3	–		–	🔑 User
HC time	20 min		5 min – 60 min (‡1)	🔑 Installer
HysParallel	applies only to LWP • 4,0 K		1 K – -10 K (‡0,5)	🔑 Installer
Cooling time	20 min		5 min – 60 min (‡1)	🔑 Installer

\*) Please enter the adjusted values. Mark not applicable with — .

## Abbreviations (selection)

Abbreviation	Meaning
2hg	Second/additional heating generator
Amb. temp.	External/ambient temperature
AS	Customer service
ASD	Defrost, Brine pressure, flow
BCP	Fan, well or brine circulation pump
BLP	Domestic hot water charging pump
BSUP	Well / brine circulating pump
BUP	Domestic hot water circulation pump
BWT	Domestic hot water thermostat
CP	Compressor
Defr/Brin/Flow	Defrost, Brine pressure, flow
DHW	Domestic hot water
EEV	Electronic expansion valve
EEVC	Electronic expansion valve (cooling)
EEVH	Electronic expansion valve (heating)
EP	Expansion board
EVI	Enhanced vapour injection
EVU	Release/off-time signal electrical supply
FUP	Floor heating circulation pump
H(D)V	Performance-controlled hydraulic module (Dual)
HC	Heating circuit
HC Add-time	Heating control more time
HC Less-time	Heating time less time
HD	High-pressure / High-pressure pressostat
HG	Hot gas
HMD	Hydraulic module
HP	Heat pump
HR	Heating circuit regulator
HS	Heat source
HS in	Heat source inlet temperature
HS out	Heat source outlet temperature
HS(D)V	Performance-controlled hydraulic station (Dual)
HT(D)	Hydraulic tower (Dual)
HUP	Heating circulation pump
KR	Cooling circuit regulator
KS	Cooling signal
L/W	Air/Water heat pump
LWA	Air/Water heat pump outdoor
LWAV	Performance controlled Air/Water heat pump outdoor
LWC	Air/Water Compact heat pump
LWCV	Performance controlled Air/Water Compact heat pump

Abbreviation	Meaning
LWDTV	Performance controlled Air/Water heat pump Dual
LWI	Air/Water heat pump indoor
LWP	Air/Water heat pump serie professional
LWV	Performance controlled Air/Water heat pump indoor
MA	Mixer open
MC	Mixing circuit
MK	Mixing circuit
MSW	Brine/Water heatpump with IO-Max Board
MZ	Mixer closed
ND	Low-pressure / Low-pressure pressostat
PEX	Party external Room station possible for WZS devices potent. ext.
PWZSV	Performance controlled Brine/Water heatstation
RAD	Radiator
RBE	Room control unit
RFV	Room remote adjuster
S/W	Brine/Water heatpump
SEC	Designation of the circuit board in the switch box of the heat pump
serv.wat.	Domestic hot water
SG	Smart Grid
SLP	Charging pump solar
SUP	Circulation pump swimming pool
SW H	Brine/Water heatpump
SWC	Brine/Water Compact heatpump
SWCV	Performance controlled Brine/Water heatpump
SWP	Brine/Water heatpump serie professional
SWT	Swimming pool thermostat
T(F)B (1) (2) (3)	Temperature sensor mixing circuit (1) (2) (3)
TA	Outdoor temperature sensor
TBW	Domestic hot water sensor
TDI	Thermal disinfection
TEE	Temperature sensor external energy source
TFL	Temperature of the liquid refrigerant
TFL 1	Temperature of the liquid refrigerant upstream of the electronic expansion valve (heating)
TFL 2	Temperature of the liquid refrigerant upstream of the electronic expansion valve (cooling)
ThDsin	Thermal disinfection
THG	Temperature sensor hot gas
TRL	Temperature sensor Return



Abbreviation	Meaning
TRL-E	Temperature sensor Return extern
TSG	Temperature sensor suction gas compressor
TSK	Temperature sensor solar collector
TSS	Temperature sensor solar tank
TVD	Temperature sensor compressor heating
TVL	Flow temperature sensor
TWA	Temperature sensor heat source outlet
TWE	Temperature sensor heat source inlet
T-WQ	Temperature heat source
TWW	Temperature sensor domestic hot water
UFH	Floor heating circuit
UWP	Circulation pump
VBO	Fan, well or brine circulation pump
VD	Compressor
W/W	Water/water heat pump
WP	Heat pump
WW	Domestic hot water
WWC	Water/water Compact heat pump
WWT	Domestic hot water thermostat
WZS	Bine/Water heatstation
WZSV	Performance controlled Bine/Water heatstation
ZIP	Circulation pump
ZUP	Additional circulation pump
ZWE	Second/additional heating generator

**i NOTE**

Abbreviations that appear in the display of the heating and heat pump controller are explained in the respective menus and submenus. Abbreviations can also be found in the operating manual of your appliance in the legends for:

- performance curves
- dimensional drawings
- installation plans
- hydraulic integration
- terminal and circuit diagrams





**alpha innotec**

ait-deutschland GmbH  
Industriestraße 3  
95359 Kasendorf  
Germany

T • +49 9228 / 9906-0  
F • +49 9228 / 9906-189  
E • [info@alpha-innotec.de](mailto:info@alpha-innotec.de)

**[www.alpha-innotec.com](http://www.alpha-innotec.com)**

**alpha innotec** – an ait-deutschland GmbH brand

Subject to technical amendments without prior notice.