







OPERATING MANUAL LUXTRONIK

-  Basic Informations
-  Basic Information on the operation
-  Program area "Info + Quick Setting"
-  Program area "Heating"
-  Program area "Domestic hot water"
-  Program area "Service"



83055200IUK - 2.0 / 2.1

UK

Heating- and heat pump control
Part 1



Please read first

This operating manual provides important information on the handling of the unit. It is an integral part of the product and must be stored so that it is accessible in the immediate vicinity of the unit. It must remain available throughout the entire service life of the unit. It must be handed over to subsequent owners or operators of the unit.

Read the operating manual before working on or operating the unit. This applies in particular to the chapter on safety. Always follow all instructions completely and without restrictions.

It is possible that this operating manual may contain instructions that seem incomprehensible or unclear. In case of questions or uncertainty, contact the factory customer service department or the manufacturer's local service partner.

This operating manual is intended only for persons assigned to work on or operate the unit. Treat all constituent parts confidentially. The information contained herein is protected by copyright. No part of this information may be reproduced, transmitted, copied, stored in electronic data systems or translated into another language, either wholly or in part, without the express written permission of the manufacturer

Symbols



Information for operators.



Information or instructions for qualified technicians and authorised service personnel.



DANGER

Indicates a direct impending danger resulting in severe injuries or death.



DANGER

Indicates danger of fatal injury due to electric current!



WARNING

Indicates a possibly dangerous situation that could result in severe injuries or death.



CAUTION

Indicates a possibly dangerous situation that could result in medium or light injuries.



IMPORTANT

Indicates a possibly dangerous situation, which could result in property damage.



NOTE

Emphasized information.



ENERGY SAVING TIP

Indicates suggestions that help to save energy, raw materials and costs.



Users and qualified technicians can set data.
Access: User.



Authorized fitter can set data; password required.
Access: Installer.



Authorised service personnel can set data. Access via USB stick only.
Access: After sales service.



Factory pre-setting, no data change possible

1., 2., 3., ... Numbered step within a multi-step instruction for action. Adhere to the given sequence.

• List.

✓ Prerequisite for an action.

→ Reference to further information elsewhere in the operating manual or in another document.

Contents



BASIC INFORMATIONS

PLEASE READ FIRST.....	2
SYMBOLS.....	2
FUNCTIONING OF THE HEATING AND HEAT PUMP REGULATOR.....	4
INTENDED USE.....	4
EXCLUSION OF LIABILITY.....	4
SAFETY.....	5
CARE OF THE UNIT.....	5
MAINTENANCE OF THE UNIT.....	5
CONTACT.....	5
WARRANTY / GUARANTEE.....	5
DISPOSAL.....	5



BASIC INFORMATION ON THE OPERATION

THE CONTROL UNIT.....	6
Status Display.....	6
Screen.....	6
"Rotary pushbutton".....	6
Error Messages.....	7
Language of the screen display.....	7
Enter digits.....	7
Determining date and time.....	7
Adjusting the contrast of the control unit display.....	7
Menu display.....	8
STANDARD SCREEN.....	8
Standard screen "Heating".....	8
Switch to Standard screen "Domestic hot water".....	8
Standard screen "Domestic hot water".....	8
Switch to the Navigation Screen.....	8
NAVIGATION SCREEN.....	9
Basic Display.....	9
Display of further program areas.....	9
Special programs display.....	9



PROGRAM AREA "INFO + SETTINGS"

SELECT PROGRAM AREA.....	10
THE MENU "INFO + SETTINGS HEATING".....	10
Setting the heating mode of operation.....	10
Setting the time programs of the heating circuit.....	11
Same switching times on all days of the week.....	11
Different switching times during the week and on weekends.....	12
Different switching times for each day.....	13

THE MENU "INFO + SETTINGS DOMESTIC HOT WATER".....	13
Setting the domestic hot water mode of operation.....	13
Setting the domestic hot water temperature.....	14
Setting the domestic hot water off-times.....	14
Maintenance program.....	14
THE MENU "INFO + SETTING COMPLETE SYSTEM".....	15



PROGRAM AREA "HEATING"

SELECT PROGRAM AREA.....	16
SETTING THE MODE OF OPERATION "HEATING".....	16
TEMPERATURE-SETTING.....	16
Change Temperature.....	16
SETTING THE HEATING CURVE.....	16
Setting the heating curves of the heating circuit.....	17
Select table "Heating curve end point.....	17
Determine the heating curve end point.....	18
Determine the difference temperature (lowered in night mode).....	18
Equalisation of the heating curve end point with the regional standard dimensioning temperature.....	18
Setting the heating curves of mixing circuit 1.....	19
Setting a fixed temperature.....	19
Fixed temperature heating circuit.....	20
Fixed temperature mixing circuit 1.....	20
TIME PROGRAM HEATING.....	20
HEATING LIMIT.....	21



PROGRAM AREA "DOMESTIC HOT WATER"

SELECT PROGRAM AREA.....	21
SETTING THE MODE OF OPERATION "DOMESTIC HOT WATER PREPARATION".....	21
SET THE DOMESTIC HOT WATER TEMPERATURE.....	21
Hot water temperature without reheating (factory setting).....	22
Hot water temperature with reheating.....	22
TIME PROGRAMS "DOMESTIC HOT WATER PREPARATION".....	23
High-speed charge.....	23
MAINTENANCE PROGRAM.....	24
Thermal Disinfection.....	24
Circulation.....	25
Time switches.....	25
Impulse.....	26
EXTRA DHW.....	26



PROGRAM AREA "SERVICE"

CALLING UP PRESET PROGRAMS	27
DETERMINING PRIORITIES.....	27
DATA LOGGER.....	27
CONTROL PANEL	28
Web server.....	28
DHCP Server	28
DHCP Client.....	29
Remote control	29
IP-address.....	29

Functioning of the heating and heat pump regulator

The heating and heat pump regulator consists of an operating element and an electronic control. This assumes control of the entire heat pump system, the domestic hot water preparation and the heating system. It automatically recognises the connected heat pump type.

The weather-controlled heating curve of the heating system with corresponding lowering and boosting times is set at the heating and heat pump regulator.

The domestic hot water preparation can be carried out via the thermostat (to be set at the customer) or temperature sensor (domestic hot water tank accessories or scope of supply) in accordance with requirements. The domestic hot water preparation via a temperature sensor enables intelligent, adaptive domestic hot water preparation with a high level of comfort.

Low-voltage and 230V signals are effectively isolated by the heating and heat pump regulator. This ensures maximum interference immunity.

Intended use

The unit may be used only for the intended purpose. This means:

- for controlling the heat pump and associated system components.

The unit may be operated only within its technical parameters.

! IMPORTANT

The heating and heat pump regulator may only be operated in conjunction with heat pumps approved by the manufacturer and accessories approved by the manufacturer.

Exclusion of liability

The manufacturer will not be liable for damage resulting from unauthorized use of the unit.

The manufacturer's liability will also be voided in the following cases:

- if work is performed on the unit and its components in a manner that does not comply with the terms of this operating manual;
- if work is performed on the unit and its components in an improper manner;
- if work is performed on the unit that is not described in this operating manual, and this work was not expressly approved in writing by the manufacturer;
- if the unit or components in the unit are modified, redesigned or removed without the express written permission of the manufacturer.

Safety

The unit is operationally safe when used for the intended purpose. The construction and design of the unit conform to the state of the art, all relevant DIN/VDE regulations and all relevant safety regulations.

Every person who performs work on the unit must have read and understood the operating manual prior to starting any work. This also applies if the respective person has already worked with such a unit or a similar unit or has been trained by the manufacturer.

Every person who performs work on the unit must comply with the applicable accident prevention and safety regulations. This applies in particular to the wearing of personal safety gear.



DANGER

Danger of fatal injury due to electric current!
Electrical connections may be installed only by qualified electricians.
Before opening the unit, disconnect the system from the power supply and secure it from being switched back on!



WARNING

Observe the relevant EN, VDE and/or applicable local safety regulations during the installation and during all electrical work.
Observe the technical connection conditions of the responsible power supply company!



WARNING

Only qualified technicians (trained heating, cooling, refrigerant and electrical technicians) may perform work on the unit and its components.



IMPORTANT

Setting work on the heating and heat pump regulator is only permitted for authorised service personnel and specialist companies who or which have been authorised by the manufacturer.



WARNING

Observe safety labels in the unit.



IMPORTANT

For safety reasons: Do not disconnect the unit from the power supply, unless the unit is being opened.



IMPORTANT

Plug X5 and screw terminals X4 of the heating and heat pump regulator are under low voltage. Use only original sensors from the manufacturer (protection class II).



IMPORTANT

Circulating pumps may be controlled only by the heating and heat pump regulator. Never shut off circulating pumps externally.



IMPORTANT

Never shut off heating circuit to the heat pump (frost protection).



IMPORTANT

Use only accessories provided by or approved by the manufacturer.

Care of the unit

The outer surfaces of the unit can be cleaned with a damp cloth and household cleaning products.

Do not use cleaning or care products that contain abrasives, acids and/or chlorine. Such products would destroy the surfaces and could also damage the technical components of the unit.

Maintenance of the unit

The heating and heat pump regulator does not require regular maintenance.

Contact

Addresses for purchasing accessories, for servicing or for answers to questions about the unit and this operating manual can be found on the internet and are kept up-to-date:

- Germany: www.alpha-innotec.de
- EU: www.alpha-innotec.com



NOTE

“T_{Outside min}” and “T_{Outside max}” are not faults that require the customer service to be phoned. The heat pump starts again automatically when the outside temperature lies within the use limits

Warranty / Guarantee

For warranty and guarantee conditions, please refer to the purchase documents.



NOTE

Please contact your dealer concerning warranties and guarantees.

Disposal

When decommissioning the unit, always comply with applicable laws, directives and standards for the recovery, recycling and disposal of materials and components of cooling units.

→ Part 2 of the manual of the Heating- and Heatpump Control, chapter “Demontage”



The control unit

Variant 1¹⁾

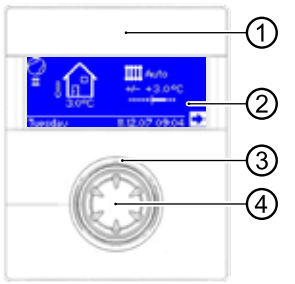

Variant 2¹⁾

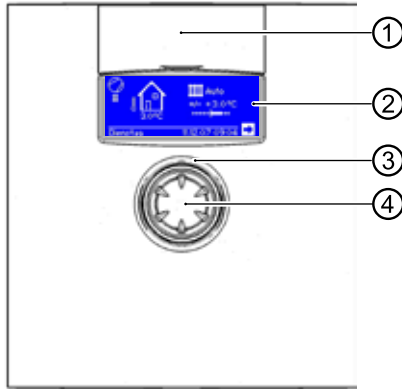

¹⁾ The variant is device-dependent

- 1 USB-interface
The port is located behind the removable flap (variant 1) or lift-up flap (variant 2)
- 2 Screen
- 3 Status display
- 4 "Rotary pushbutton"

STATUS DISPLAY

- Ring around the rotary pushbutton lights up **green** = System operating **properly**
- Ring around the rotary pushbutton lights up **green/red** = **self-resetting operational interruption**
- Ring around the rotary pushbutton lights up **red** = **malfunction**

NOTE
The display of the control unit has to be accessible and visible any time. Please check regularly the system status from your heatpump.
The unit is configured in the factory to fault mode without ZWE. If it is set to fault with ZWE, this means: In the event of a fault and failure of the heat pump, the electrical heating element is released. This can lead to increased energy costs.

SCREEN

Operating information, functions and setting options for the heating and heat pump regulator and the heat pump system as well as error messages are displayed in the screen of the operating element.

The screen is normally not illuminated. If the "rotary pushbutton" is used, the screen illumination will switch on. It switches off automatically if the "rotary pushbutton" is not pressed after longer than 10 minutes.

Dark background (inverted) = Symbol or menu field is activated

- Activating and selecting the navigation arrow will take you from one menu level to the next higher or lower one.
- Some menus require the settings you have made to be saved. You can do so through activation and selection of . You can also cancel the settings you have made through activation and selection of .

If a menu has more entries than the screen can display, a scroll bar will appear on the left of the screen. This shows the location you are at in the menu. If no symbol or menu field is selected, you can scroll down the screen display by turning the "rotary pushbutton" to the right. This displays further menu entries. You can scroll back up the screen display again by turning the "rotary pushbutton" to the left.

"ROTARY PUSHBUTTON"

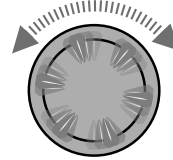

Turn
Activate symbol or menu field
or
Scroll the screen display down (or up).



Press (short)
Select the selected symbol (= change to the corresponding program level)
or
enable the menu field for entering data and values.

Example in the standard screen: Change temperature

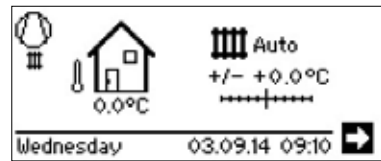

Turn
Select the "Temperature change" symbol

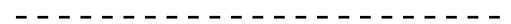

Press (short)
Activate the input field "Temperature change"

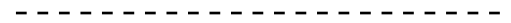

Turn
Change the temperature

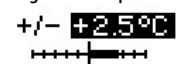

Press (short)
Finish the temperature change

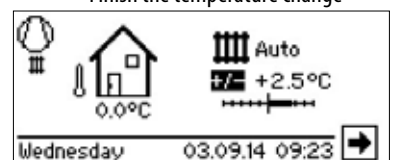

ERROR MESSAGES

If a fault occurs in the system, a corresponding error message will appear in the screen.

! IMPORTANT

Before acknowledging a fault, make sure to read the chapters "Error Diagnosis / Error Messages" and "Acknowledging a Fault.."

→ Part 2 of the manual of the Heating- and Heatpump Control, Overview (Appendix) "Error Diagnosis / Error Messages" and "Acknowledging a Fault."



Press (7 seconds long)

Acknowledge error message and restart the heat pump system (= manual reset).

LANGUAGE OF THE SCREEN DISPLAY

You can specify the language to be used for displaying the menus and texts in the screen.

Example: Change language from "German" to "English"

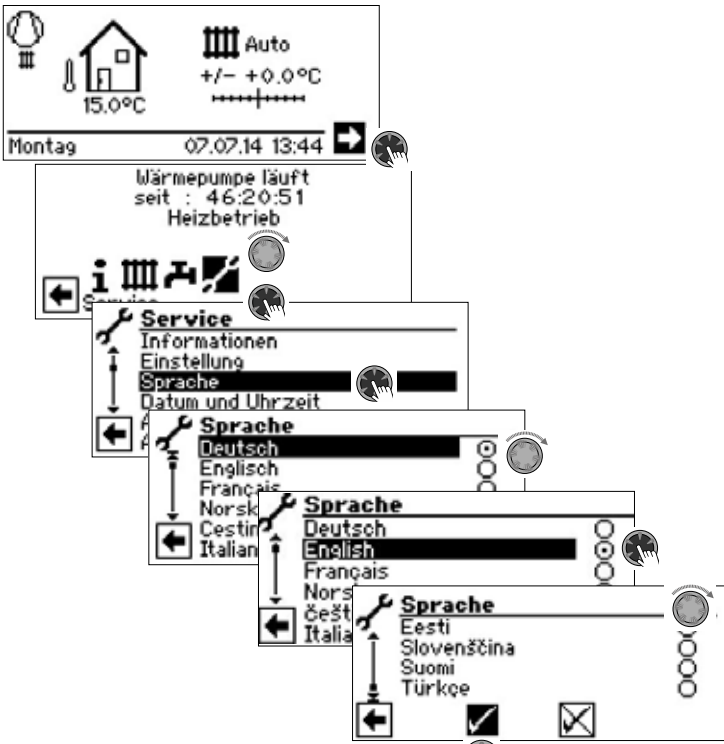

Select the desired language, scroll down the menu and save setting

The language selection is also displayed when the heat pump is switched on for the first time.

ENTER DIGITS

→ Description in Part 2 of the operating manual for the heating and heat pump control, program area "Service", "Making settings", section "Determine data access".

DETERMINING DATE AND TIME

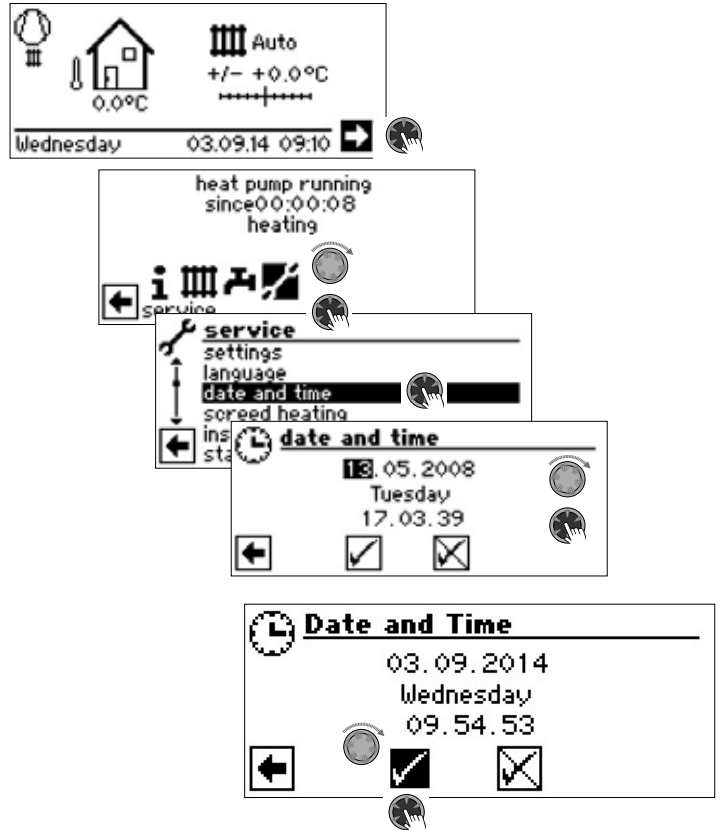

ADJUSTING THE CONTRAST OF THE CONTROL UNIT DISPLAY

Adjust the contrast of the control unit display to your needs.

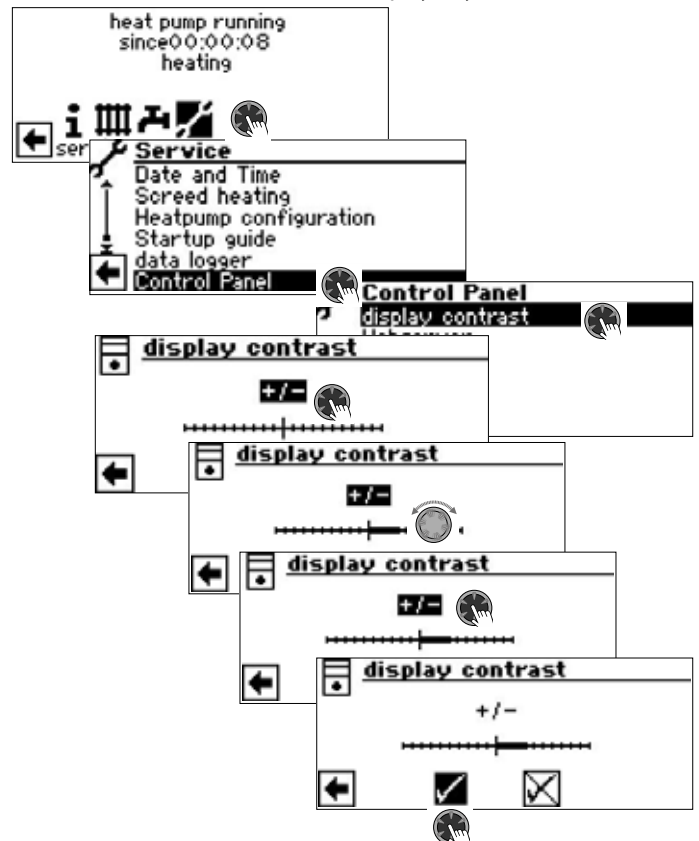

Adjust the contrast by turning the "rotary pushbutton"



MENU DISPLAY

The menu structure is constructed such that parameters that are not relevant for the system situation or for the heat pump type are hidden from view. For this reason, some of the parameters documented in this program area may not appear in your heating and heat pump controller or may appear in a different order than is shown in this operating manual.

Standard screen

The standardscreen (= standard-menu) is used for a fast information about the selected mode of operation. Additionally you can set basic settings fast and convenient.

STANDARD SCREEN "HEATING"

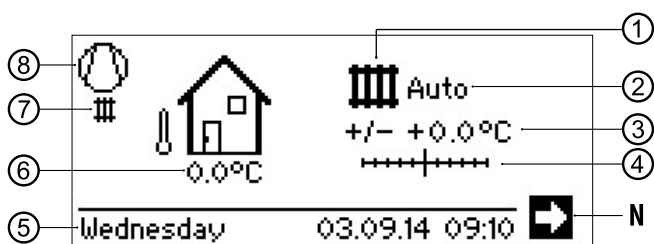

1 Symbol for program area "Heating"

The symbol used for the heating indicates that the adjoining displays and setting options are only relevant to the heating. However, you can press the symbol to switch between the different supply types of the heat pump. This allows you to, for instance, display the symbols used for heating hot water, cooling or swimming pool. The options vary with the heating system you own and the consumers you have connected to it.

2 Current heating mode of operation

Auto, Party, Holidays, 2 hg or Off

3 Digital temperature display

Shows the extent to which the hot water return flow temperature is to deviate from that of the set heating curve.

Maximum value of the potential deviation: $\pm 5^\circ\text{C}$

4 Temperature scale

Shows in graphical form the extent to which the hot water return flow temperature is to deviate from that of the set heating curve.

Maximum value of the potential deviation: $\pm 5^\circ\text{C}$

N Navigation arrow

here: Change to the navigation screen

5 Date and time

Selection of the menu line leads directly to the settings menu

6 Current outdoor temperature

7 Current operating mode

for example:

	Heating		EVU
	Domestic hot water		Pump flow
	Screed heating		Error
	Defrosting		Cooling

8 Compressor

The compressor symbol will turn for as long as the compressor is running.

NOTE

The navigation arrow is activated automatically in the initial and idle state of the standard screen (silhouetted).

SWITCH TO STANDARD SCREEN "DOMESTIC HOT WATER"

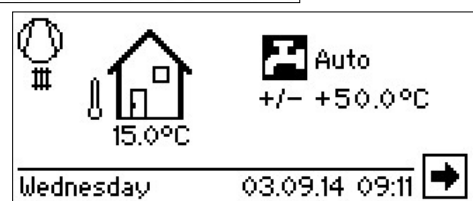
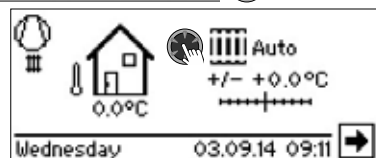
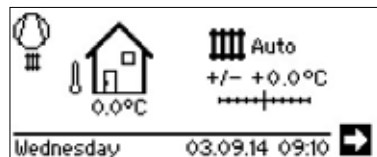

STANDARD SCREEN "DOMESTIC HOT WATER"

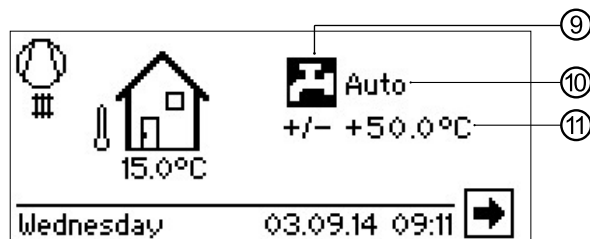

9 Symbol for program area "Domestic Hot Water"

Indicates that domestic hot water functions are being controlled in the standard screen.

10 Current domestic hot water mode of operation

Auto, Party, Holidays, 2 hg or Off

11 Set temperature for heating hot water

SWITCH TO THE NAVIGATION SCREEN

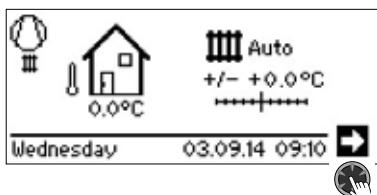

Navigation Screen





The navigation screen provides an overview of the various program areas of the heating and heat pump regulator.

BASIC DISPLAY









- 1 Current operating state of the heat pump with time indication
- 2 Reason for the current operating state or fault message
- 3 Symbols for the program areas of the heating and heat pump regulator
- 4 Information on the activated symbol

Standard symbols which are always displayed are:

-  Symbol for program area "Information and Quick Setting"
Operating information and system operation by the user
Enabled for all users
-  Symbol for program area "Heating"
Program area for setting all parameters for the heating and mixing circuit
Only for qualified technicians
-  Symbol for program area "Domestic Hot Water"
Program area for setting all parameters for domestic hot water preparation
Only for qualified technicians
-  Symbol for program area "Service"
Program area for setting the basic system parameters
Only for authorised qualified technicians and service personnel
In parts, access via password or USB stick only

DISPLAY OF FURTHER PROGRAM AREAS











Depending on your system and the configuration of the heating and heat pump regulator (system settings and / or installed additional boards), further program area symbols can be shown in the navigation screen:

-  Symbol for program area "Parallel mode Master".
Connection of up to 4 heat pumps with one another.
Only for qualified technicians.
-  Symbol für Programmbereich "Parallel mode Slave".
Only for qualified technicians.
-  Symbol for program area "Cooling"
-  Symbol for program area "Swimming pool heating"
-  Symbol for program area "Photovoltaics"
-  Symbol for program area "Solar system"

SPECIAL PROGRAMS DISPLAY

If special programs are active, their symbols will be displayed in the navigation screen.



-  Fitter or service access unlocked
-  Ventilation program
-  Screed heating program
-  Preset program
-  Forced heating
-  Forced domestic hot water
-  Forced defrosting
-  USB-stick is plugged in
-  Cold start (interrupt)
Air-water heat pumps are equipped with a cold start function. The function is activated if, when outside temperature reach < 10°C, the return temperature falls below 15°C. In addition to the heat pump, a second heat generator is required for this function. Cold start is terminated at a return temperature of 23°C. It is possible to interrupt the cold start by pressing the symbol . The cold start will then remain deactivated until the next time the regulator is started.

NOTE
If you select and activate the symbol of a special program, you will be taken directly to the relevant special program.

In some screens selections can / must be made. In general:

In circular fields you can only select one option:

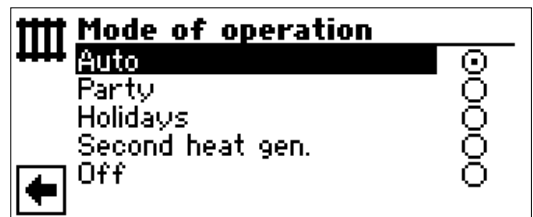

Boxes can be "clicked" multiple times:

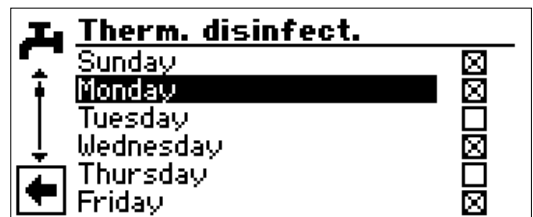



i Program area "Info + settings"

SELECT PROGRAM AREA

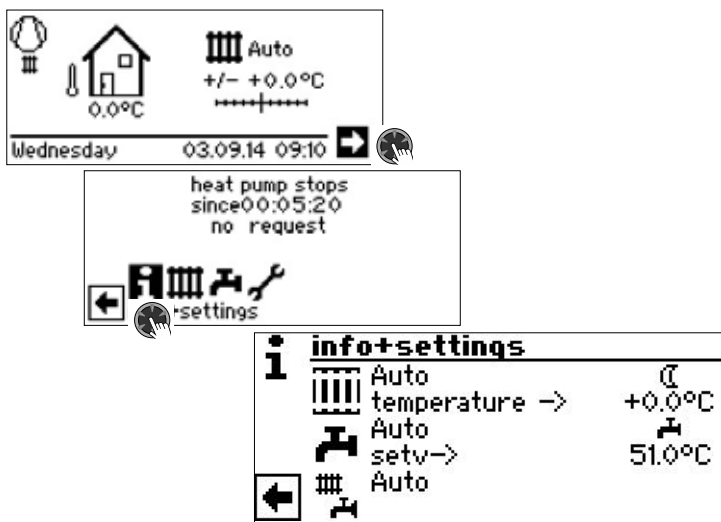

THE MENU "INFO + SETTINGS HEATING"

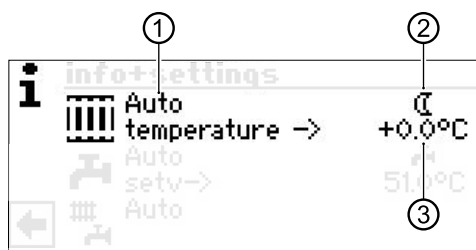

1 Menu field "Current mode of operation"

Possible displays: Auto
Party (= Continuous daytime operation)
Holidays
Second heat gen. (=Second heat generator)
Off

2 Menu field "Heating time progs"

Shows whether the heat pump is operating in day or night mode:

- * Symbol for day mode: Heating is raised
- ☾ Symbol for night mode: Heating is lowered

3 Menu field "Temperature"

Shows the extent to which the currently required hot water return flow temperature deviates from that of the set heating curve.

SETTING THE HEATING MODE OF OPERATION

i NOTE

This menu performs the same function as the quickly changing the hot water return flow temperature in the standard screen.

Heating circuit and mixing circuit 1 are the same output. Further mixing circuits (mixing circuit 2, mixing circuit 3 with installed additional board) are only displayed here if they are set to "discharge" or "heat + cool" in the system settings

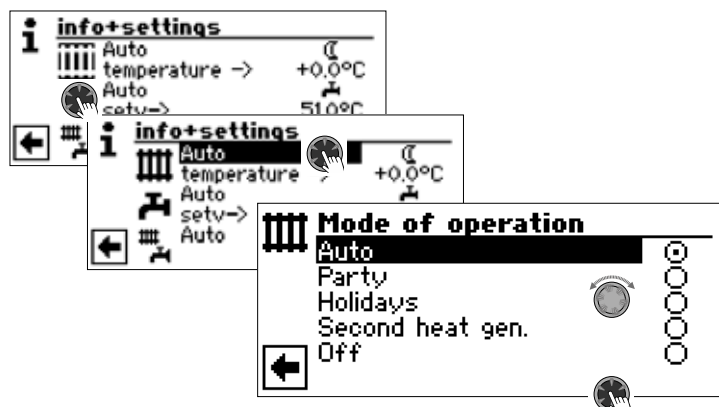

The current mode of operation is highlighted with ☉:

Auto

Heating circuit works according to programmed time programs.

Party

Continuous heating boost. The settings for night mode are switched off *straightaway for the duration of 24 hours or until another mode of operation is selected.*

Holidays

Continuous heating reduction. The settings for day mode are switched off *straightaway until the set date is reached or until another mode of operation is selected.*

If the "Holidays" mode of operation is selected, the screen changes to the menu "End of holidays"

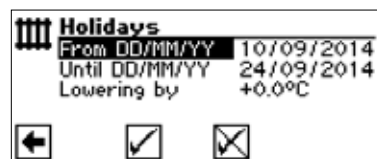

From DD/MM/YYYY

Begin of holidays: Set day / month / year

Until DD/MM/YYYY

End of holidays: Set day / month / year

lowering by

Set lowering

Value range:

-15 °C – + 10 °C
adjustable steps 0,5 °C

2nd heat gen. Second heat generator

The programmed time programs control the heating, *without* switching on the heat pump.

Off

The heating is switched off (= summer mode), the antifreeze function is switched on (return setpoint = 15 °C; the heat pump starts operating if the return setpoint is fallen below)

For air / water heat pumps and an outdoor air temperature of less than 10°C, the value switches to 20°C return setpoint

Temperature

Change hot water return flow temperature of the set heating curve by the required temperature (value range: $\pm 5\text{ }^{\circ}\text{C}$, adjustable steps $0,5\text{ }^{\circ}\text{C}$):

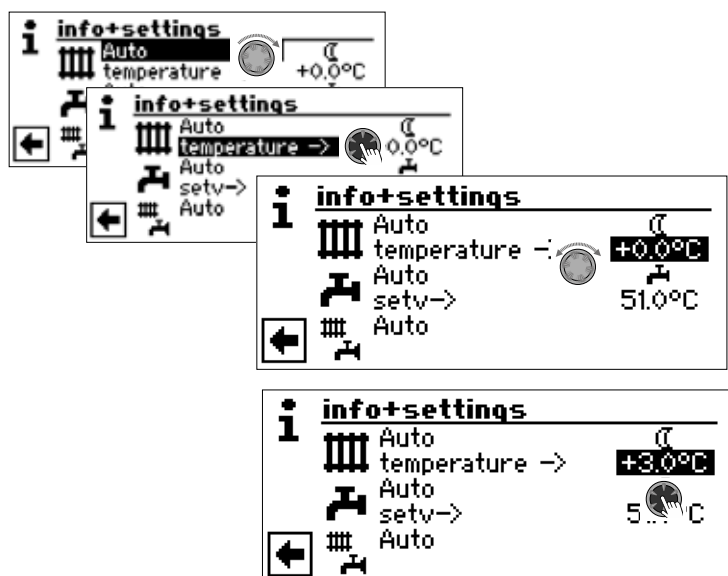

Finish entry by pressing the "rotary pushbutton". This saves the required temperature.

SETTING THE TIME PROGRAMS OF THE HEATING CIRCUIT

NOTE

You can only select and activate the "Heating timers" – * or C – if the mode of operation "Auto" is active.

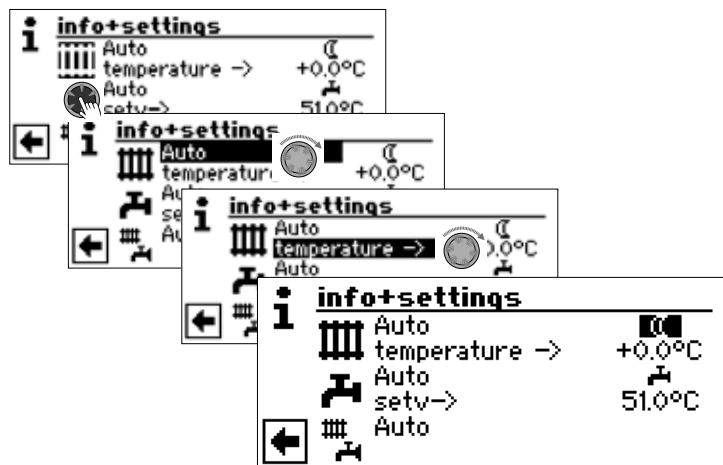

If you select the menu field "Settings heating", the screen will change either to the menu "Timers" or directly to the menu "Timer Heating circuit" (depending on the system setting made by the authorised service technician):

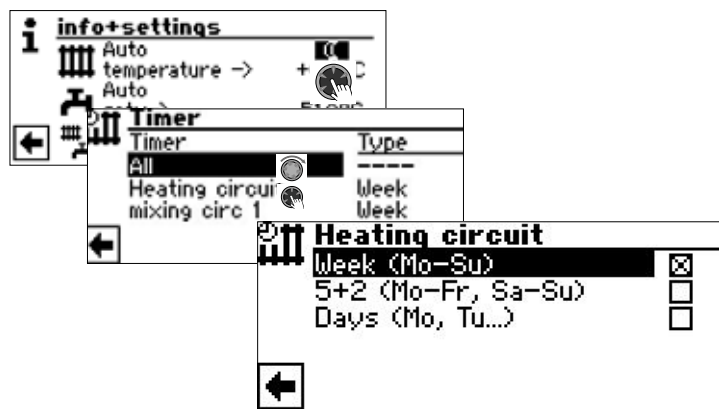

Week (Mo – Su)

Same times for all days of the week

5 + 2 (Mo – Fr, Sa – Su)

Different times during the week and on weekends

Days (Mo, Tu,...)

Different times for each day



NOTE

The time programs are programmed in the menus "All" and "Mixing circ 1" in the same way as the example described below "Timers Heating circuit".

SAME SWITCHING TIMES ON ALL DAYS OF THE WEEK

You can specify a maximum of three times periods within 24 hours at which the heating is to be raised. The specified time periods apply for every day of the week.

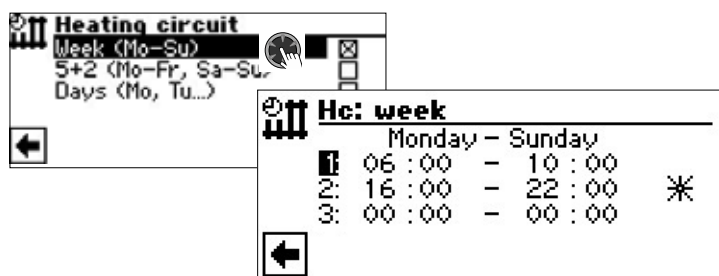

Monday – Sunday

The displayed time programs apply for every day of the week. The heating is raised within the time period indicated (= day mode). The heating is also lowered at the remaining times (= night mode).

1:

Switching channel 1 with typical time period. In the example shown, the heating is increased daily from 06:00 – 10:00 hours.

2:

Switching channel 2 with typical time period. In the example shown, the heating is increased daily from 16:00 – 22:00 hours.

3:

Switching channel 3 with typical time period. Not specified in the example shown.

* Symbol for "Day mode"

Indicates that the heating works in day mode at the specified time periods, i.e. it is increased.



NOTE

With a time period of 00:00 – 00:00 the heating is generally lowered. It only works in night mode.

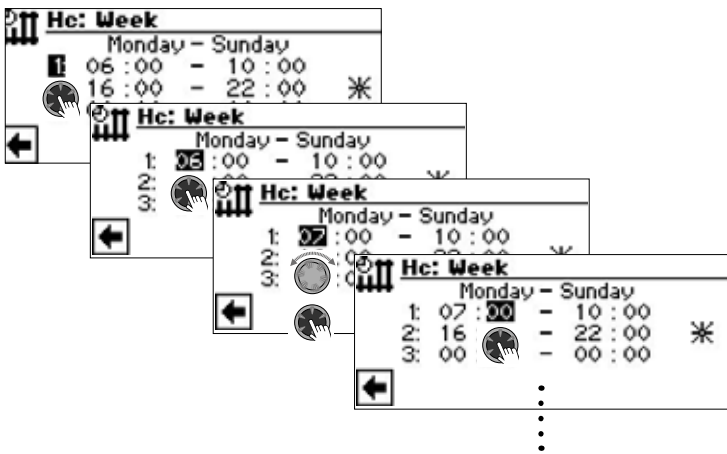

Scroll down the menu. Settings made are saved by activating and selecting or cancelled by activating and selecting .

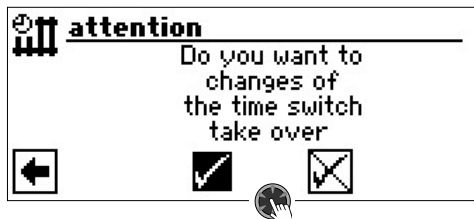

NOTE

If the settings have been saved, the time settings "Hc: Week" overwrite existing time settings in "Hc: 5+2" and "Hc: Days". At the same time, the switching time control "Week (Mo - Su) is switched on and automatically marked by in the time programs submenu "Heating circuit".

Different switching times during the week and on weekends

You can specify a maximum of three time periods at which the heating circuit is to be raised for both day groups Monday - Friday and Saturday - Sunday (= Weekend).

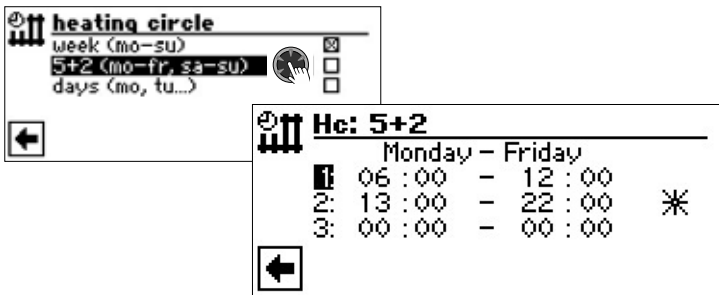

Monday - Friday

The displayed time programs apply for every day of the week. The heating is raised within the time period indicated (= day mode). The heating is also lowered at the remaining times (= night mode).

- 1:** Switching channel 1 with typical time period. In the example shown, the heating is increased daily from 06:00 - 12:00 hours.
- 2:** Switching channel 2 with typical time period. In the example shown, the heating is increased daily from 13:00 - 22:00: hours.
- 3:** Switching channel 3 with typical time period. Not specified in the example shown.

✱ Symbol for "Day mode"

Indicates that the heating works in day mode at the specified time periods, i.e. it is increased.

NOTE

With a time period of 00:00 - 00:00 the heating is generally lowered. It only works in night mode.

Scroll down the menu:

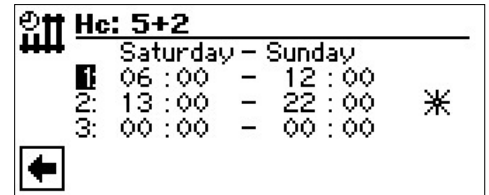

Saturday - Sunday

The displayed time programs apply for every day of the week. The heating is raised within the time period indicated (= day mode). The heating is also lowered at the remaining times (= night mode).

- 1:** Switching channel 1 with typical time period. In the example shown, the heating is increased daily from 06:00 - 12:00 hours.
- 2:** Switching channel 2 with typical time period. In the example shown, the heating is increased daily from 16:00 - 22:00 hours.
- 3:** Switching channel 3 with typical time period. Not specified in the example shown.

✱ Symbol for "Day mode"

Indicates that the heating works in day mode at the specified time periods, i.e. it is increased.

NOTE

With a time period of 00:00 - 00:00 the heating is generally lowered. It only works in night mode.

Scroll down the menu. Settings made are saved by activating and selecting or cancelled by activating and selecting .

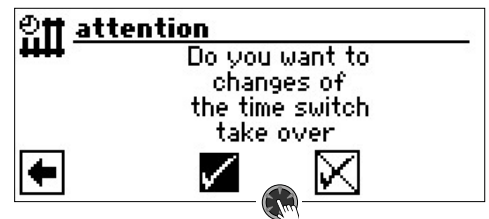

Different switching times for each day

NOTE

If time programs have been programmed in the time programs "Week (Mo – Su)" or "5 + 2 (Mo – Fr, Sa – Su)" and you wish to diverge from this on (a) certain day(s), you can program the program times for this/these day(s) here correspondingly

You can specify a maximum of three time periods for each day at which the heating is to be raised.

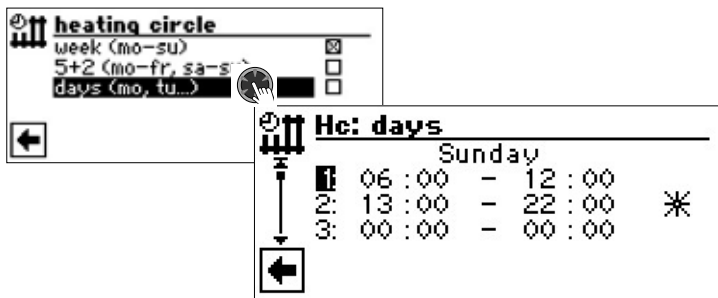

Sunday

The displayed time programs apply for every day of the week. The heating is raised within the time period indicated (= day mode). The heating is also lowered at the remaining times (= night mode).

1: Switching channel 1 with typical time period. In the example shown, the heating is increased daily from 06:00 – 12:00 hours.

2: Switching channel 2 with typical time period. In the example shown, the heating is increased daily from 13:00 – 22:00 hours.

3: Switching channel 3 with typical time period. Not specified in the example shown.

* Symbol for "Day mode"

Indicates that the heating works in day mode at the specified time periods, i.e. it is increased.

NOTE

With a time period of 00:00 – 00:00 the heating is generally lowered. It only works in night mode.

The menus for other days (Monday, Tuesday ...) are called up by scrolling through the screen.

Scroll down the menu. Settings made are saved by activating and selecting or cancelled by activating and selecting .

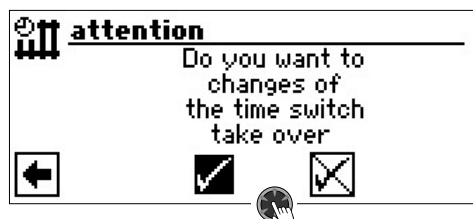

THE MENU "INFO + SETTINGS DOMESTIC HOT WATER"



1 Menu field "Current mode of operation"

Possible displays: Auto
Party (=Continuous daytime operation)
Holidays
Second heat gen. (=Second heat generator)
Off

2 Menu field "Off-times"

Displays the status of the domestic hot water preparation::

Domestic hot water preparation enabled
 Domestic hot water preparation stop

3 Menu field "Hot wasser temperature".

Displays the required domestic hot water temperature (= setpoint value)

NOTE

Whether the menu field "Domestic hot water" and menu line title "Setpoint domestic hot water temperature" are displayed depends on the system setting.

SETTING THE DOMESTIC HOT WATER MODE OF OPERATION

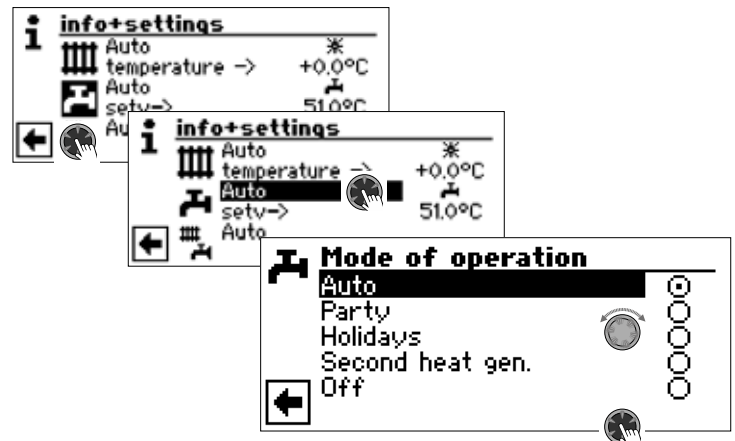

The current mode of operation is highlighted with :

Automatic

Domestic hot water preparation is *stopped* after the programmed program times.

Party

The domestic hot water preparation works in continuous mode *straightaway* for the duration of 24 hours until another mode of operation is selected.

Holidays

The domestic hot water preparation is stopped *straightaway* until the set date is reached or until another mode of operation is selected.

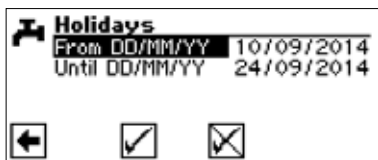

From DD/MM/YYYY
begin of holidays: set day / month / year

Until DD/MM/YYYY
end of holidays: set day / month / year

NOTE
If the “Thermal disinfection” maintenance program has been set, it rests and does not start again until the first domestic hot water preparation after the “Holidays” have elapsed.

Second heat gen.

The programmed program times control the domestic hot water preparation, *without* selecting the heat pump

Off

Domestic hot water preparation is switched off.

SETTING THE DOMESTIC HOT WATER TEMPERATURE

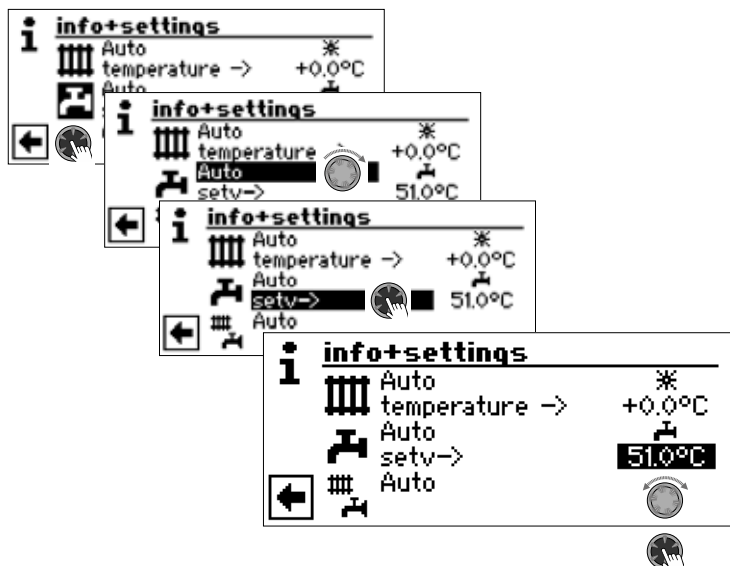

Set the required domestic hot water temperature (= setpoint value): 30 °C.
Terminate input. This saves the required temperature.

NOTE
In conjunction with domestic hot water tanks recommended by the manufacturer, your heat pump can generate domestic hot water temperatures which are around 7 K lower than the maximum flow temperature of your heat pump.

NOTE
If a domestic hot water temperature is set which cannot be attained, the heat pump will initially switch to “Error high pressure”. This is followed by a self-resetting fault (If heating is required, this will also be operated). After 2 hours have passed, the domestic hot water preparation starts

again. Nevertheless, the program of the heating and heat pump regulator automatically lowers the setpoint value for this by an initial 1 °C. If this setpoint temperature cannot be attained either, the process is repeated until a temperature can be attained.

The set desired value remains unaffected and is displayed unchanged.

SETTING THE DOMESTIC HOT WATER OFF-TIMES

You can only select and activate the “Off-times” – or – if the “Automatic” mode of operation is active.

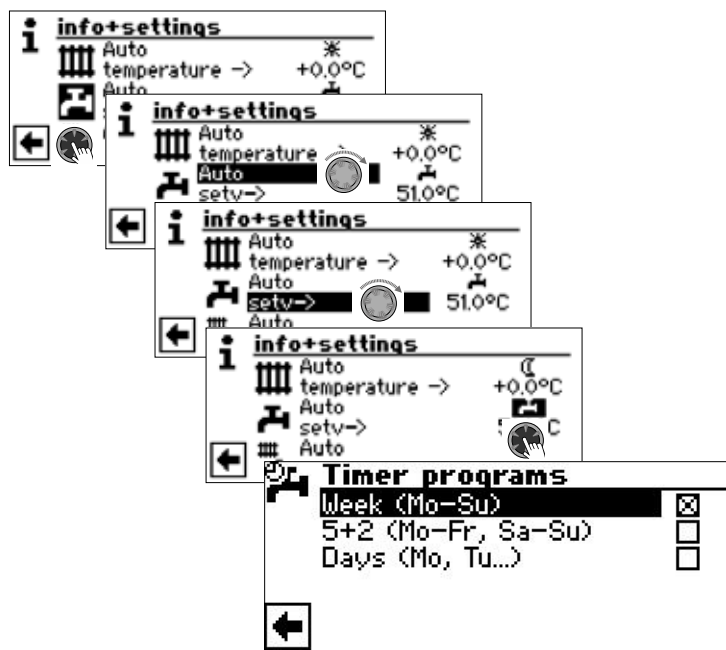

→ The time programs for the domestic hot water are programmed as described in chapter “Setting the time programs of the heating circuit” (page 11).

NOTE
When programming, ensure that the time periods which you specify in the area “Time programs domestic hot water preparation” are **off times**. The domestic hot water preparation is switched off in the time periods entered.

If you require domestic hot water despite active off-time(s), you can select a domestic hot water preparation and then terminate it again via the function “High-speed charge” by bypassing the programmed off-time(s).

→ page 23, “High-speed charge”

MAINTENANCE PROGRAM

→ page 24, “Thermal disinfection” and “Cirkulation”

THE MENU "INFO + SETTING COMPLETE SYSTEM"

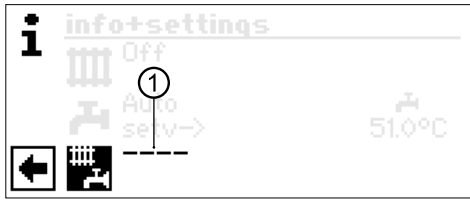

1 Menu field "current mode of operation"

Possible displays: Auto
Party (=Continuous daytime operation)
Holidays
Off

A dotted line means that the individual areas of the system work in different modes of operation.

Proceed as follows if you wish to specify a common mode of operation for the individual areas of your system:

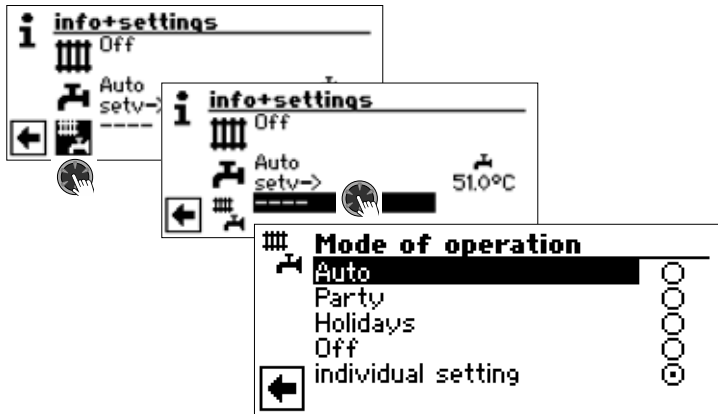

The current mode of operation is highlighted with ●

You can now choose which mode of operation is to apply for all areas of your system. At the same time, the mode of operation "Holidays" requires a "Program end" to be programmed..

→ page 10, "Setting the heating mode of operation", "Holidays"

NOTE

The mode of operation you select in the menu "Complete system" is automatically assigned to **all** individual areas of your system.

Example:

You wish to set the heating and domestic hot water preparation to continuous day mode for a short time owing to a party in your house. After the party, all areas of your system are to operate in automatic mode.

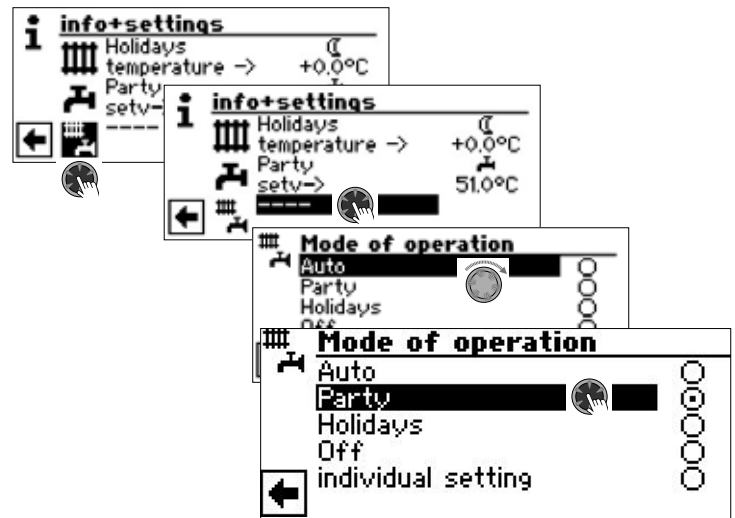

After the party has finished:

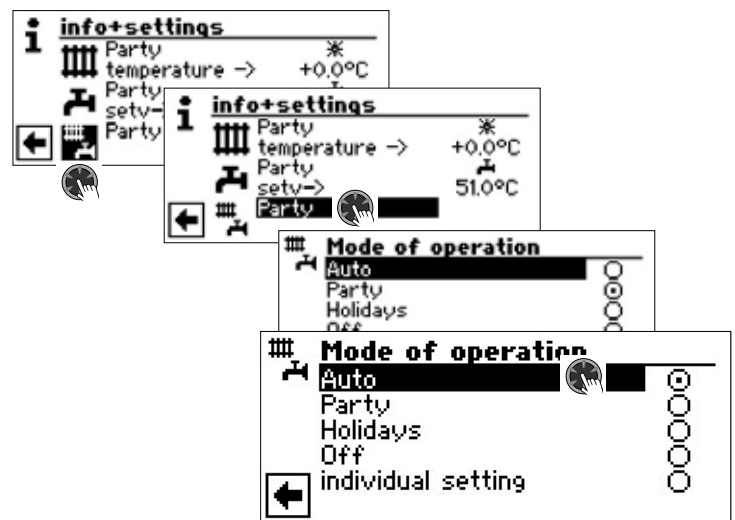

Automatik

All areas of your system are switched over to the "Automatic" mode of operation and work as specified by the set time.

NOTE

If you want the individual areas of your system to work in different modes of operation (for example heating "Off", domestic hot water preparation "Automatic"), you have to select the menu field "Indiv. setting" (= individual setting). You can then see the required mode of operation via the menu of the relevant program area of your system (heating, domestic hot water, ...).

→ page 10, "Setting the heating mode of operation" and page 13, "Setting the domestic hot water mode of operation"



Program area "Heating"

SELECT PROGRAM AREA

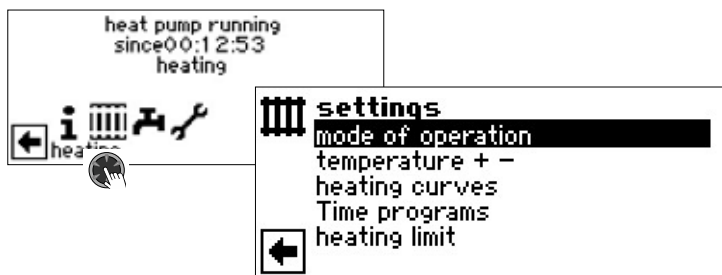

Menu field "Operating Mode"

takes you to the menu "Heating Operating Mode"

Menu field "Temperature + -"

takes you to the menu "Heating Temperature-Finetuning"

Menu field "Heating Curves"

takes you to the menu "Heating curves"

Menu field "Timer program"

takes you to the menu "Heating Time programs"

Menu field "Heating limit"

takes you to the menu "Heating limit"

SETTING THE MODE OF OPERATION "HEATING"



The current mode of operation is highlighted with .

→ page 10, "Setting the heating mode of operation"

TEMPERATURE-SETTING

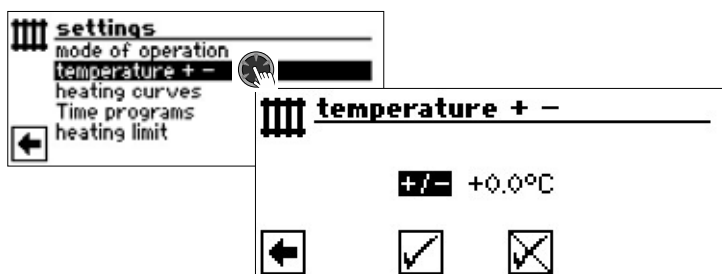

Menu field "Temperature deviation"

Entries are displayed in 0.5 °C increments.

Reference variable: Set heating curve

NOTE

This menu allows you to carry out the fine setting of the heating curves. If temperature changes are saved, this is accepted auto-adaptively into the heating curves.

This means: On the basis of the changes in the menu "Temperature + -", the program of the heating and heat pump regulator calculates the base and end point of the heating curves in relation to the external temperature and offsets it

Change Temperature

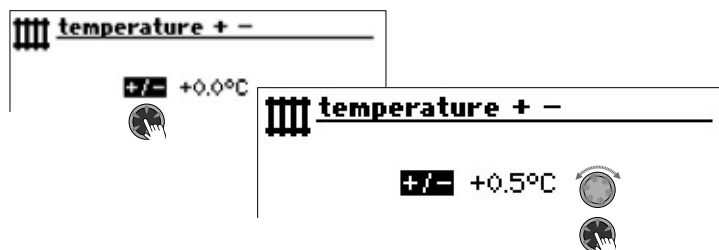

Entries are displayed in 0.5 °C increments.

Reference variable: Set heating curve

Increase temperature:

Activate and select menu field "Warmer". The hot water return flow temperature is increased by 0.5 °C with every turn.

Lower temperature:

Activate and select menu field "Colder". The hot water return flow temperature is lowered by 0.5 °C with every turn.

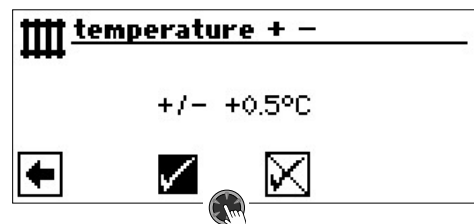

NOTE

First only change the temperature by 0.5 °C. Wait 2 to 3 days before changing again and check how the room temperature has developed.

NOTE

When saved, the heating curves are automatically changed by the temperature values entered. The values in the menu fields "Temperature scale" and "Temperature deviation" are set to zero after saving in the menu "Temperature + -".

Once you have saved your settings, the program provides a corresponding feed back in the screen.

SETTING THE HEATING CURVE

The hot water temperatures of heating systems calculated in relation to the external temperature are designated as heating curve. Within specified limit values, the hot water temperatures rise (fall) if the external temperature falls (rises).

NOTE

If "Analog In" is selected under system settings, the heating curve is controlled by a superordinate control.

NOTE
The settings for the heating circuit control how the heat pump is switched on and off depending on the temperature.

SETTING THE HEATING CURVES OF THE HEATING CIRCUIT

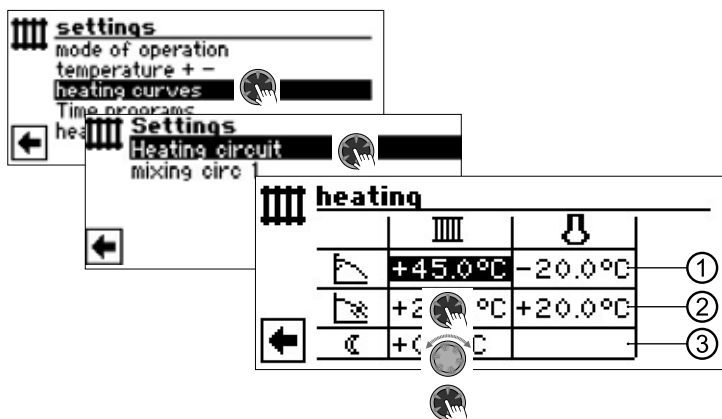

NOTE
If the menu "Heating curves" appears, select the menu field "Heating circuit". The heating curves for the heating circuit can be programmed if no fixed temperature is set.

→ page 19, "Setting a fixed temperature"

Return flow temperature of heating circuit

Reference value for external temperature

1 Table line "Heating curve end point"

Symbol for "Heating curve end point"

45 °C Table field "Heating curve end point"

Example value here: 45 °C

-20 °C Table field "Reference value for external temperature" (= program setting that cannot be changed)

The example shows that the hot water return flow temperature is to be 45 °C at an external temperature of -20 °C.

2 Table line "Parallel offset"

Symbol for "Parallel offset"

20 °C Table field "Parallel offset".

Example value here: 20 °C (neutral)

20 °C Table field "Reference value for external temperature"

The example shown indicates that the base of the heating curve is to be 20 °C at an external temperature of 20 °C.

An increase in the temperature value in the table field "Parallel offset" to, for example, 22 °C causes a parallel offset of the heating curve by 2 °C upwards, while a reduction to, for example, 18 °C causes a parallel offset of the heating curve by 2 °C downwards.

3 Table line "Night reduction"

Symbol for night mode: Heating is lowered

-5 °C Table field "Difference temperature"

The example shown indicates that the heating in night mode is lowered by 5 °C in comparison to day mode.

NOTE
The night reduction temperature can also be set in the "Temperatures" section under "night lowering HC" or under "night lowering MC1".

→ Part 2 of the controller manual, program area "Service", section "Determining temperatures"

Select table "Heating curve end point"

heating		
	III	IV
	+45.0°C	-20.0°C
	+20.0°C	+20.0°C
	+0.0°C	

Set the return flow temperature value in the table field "Heating curve end point".

NOTE
The heating curve end point always refers to an external temperature of -20 °C. If the heat pump is used in a climatic zone in which the external temperature value of -20 °C is not reached, you need to equalise the heating curve end point with the regional standard design temperature.

→ page 18, "Equalisation of the heating curve end point with the regional standard dimensioning temperature"

NOTE
The temperature values refer to the return flow. You need to subtract the spread for flow temperatures.

Example diagram:

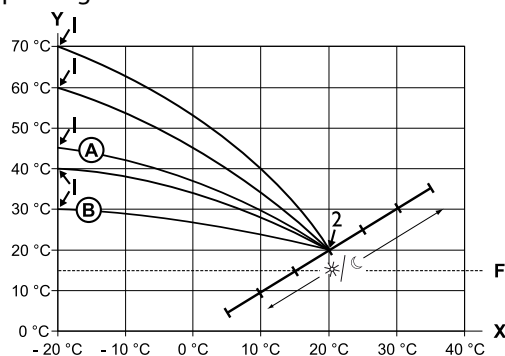

X External temperature

Y Return temperature

1 Heating curve end point

2 Heating curve base

F Antifreeze

(A) Heating curve with heating curve end point of 45 °C return temperature (for example when using radiators)

(B) Heating curve with heating curve end point of 30 °C return temperature (for example when using floor heating) respectively at -20 °C external temperature as well as heating curve base of 20 °C return temperature at +20 °C external temperature.

Set further parameters or scroll down to the bottom of the screen and continue with page 18, "Equalisation of the heating curve end point with the regional standard dimensioning temperature" "Equalisation of the heating curve end point with the regional standard dimensioning temperature."



DETERMINE THE HEATING CURVE END POINT

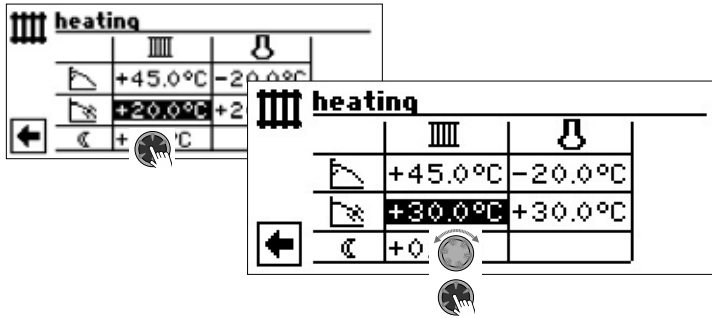

Set return temperature value.

Set return temperature value. A turn to the right results in a parallel offset of the heating curve by 0.5 °C upwards. A turn to the left results in a parallel offset of the heating curve by 0,5 °C downwards.

NOTE

The parallel offset has an effect on the day and night mode.

Example diagram:

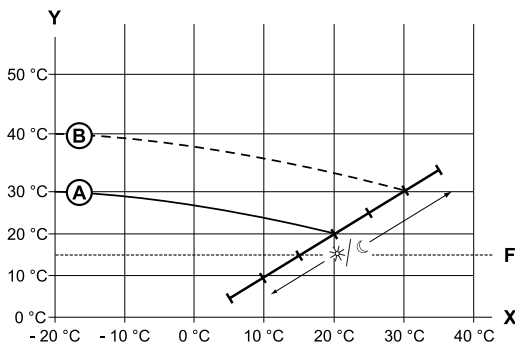

- X External temperature
- Y Return temperature
- F Antifreeze
- Ⓐ Heating curve with heating curve end point at 30 °C return temperature and heating curve base at 20 °C return temperature
- Ⓑ Heating curve after parallel offset moved by 10 °C upward.

Finish entry in the table field "Parallel offset".

Set further parameters or scroll down to the bottom of the screen and continue with page 18, "Equalisation of the heating curve end point with the regional standard dimensioning temperature".

Determine the difference temperature (lowered in night mode)

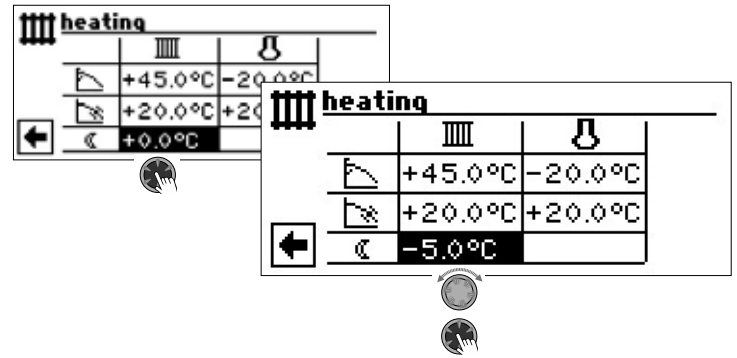

Example diagram:

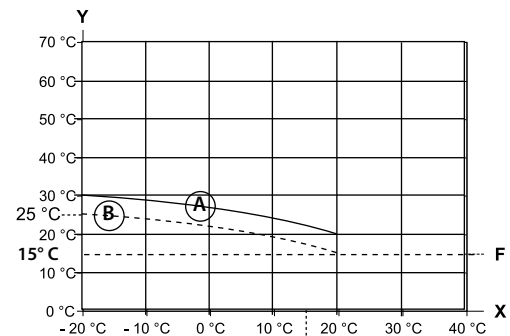

- X External temperature
- Y "Return temperature"
- F Antifreeze
- Ⓐ Heating curve in daytime mode
- Ⓑ Heating curve offset parallel by -5 °C in night mode

Viewed over the entire range, the heating curve in night mode is 5 °C below the heating curve in day mode.

NOTE

If your system works in the mode of operation "Auto(matic)", it will automatically switch over between daytime (raise) and night-time mode (lower).

Equalisation of the heating curve end point with the regional standard dimensioning temperature

NOTE

Required only if the heating curve is to be compensated to regional standard design temperature.

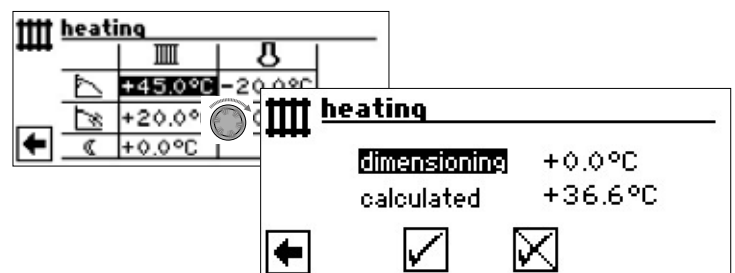

- Menu line "dimensioning" regional standard design temperature
- Menu line "calculated" Calculated temperature heating curve end point" for regional standard dimensioning temperature

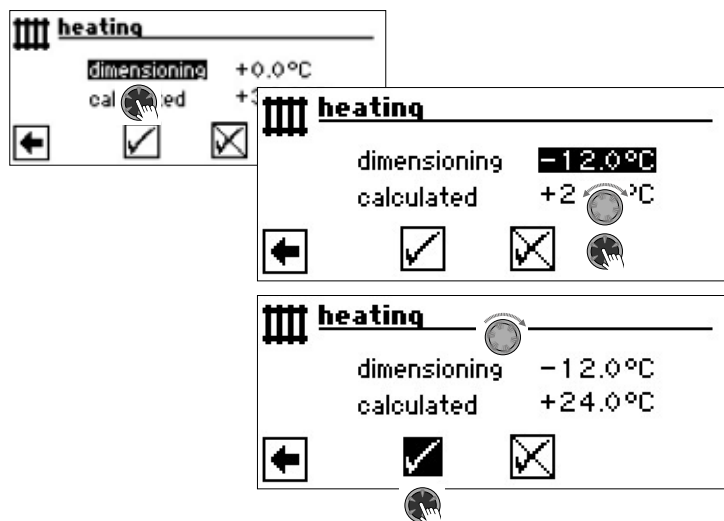

The program of the heating and heat pump regulator now calculates the actual return temperature at -12 °C for the heating curve end point and displays this in the menu field “Calculated”. In the example +24,0 °C:

If the calculated return temperature corresponds to the return temperature you require, you can quit the menu.

If, however, the system operates to another return temperature, select and activate the table field “Heating curve end point” in the table line “Heating curve end point”, and change the return temperature value upwards or downwards (depending on whether a higher or lower value is required).

Now check the temperature value displayed after the menu field “Calculated”.

If the calculated value now corresponds to the return temperature you require, you can quit the menu.

Otherwise scroll all the way up the menu “Heating curve Heating” and repeat steps until the calculated value comes closest to the required return temperature.

NOTE
An exact correspondence of the calculated value with the required return temperature is hardly possible, as you can only set the return temperature value in 0.5 °C- increments in the “Heating curve end point” menu field. Accept a return temperature which is as close as possible to what you are aiming for.

NOTE
Adjusting the heating curve to reasonable settings is crucial for the heat pump to operate in the most energy efficient way. Setting the heating curve too high will increase the total energy consumption of the system!

NOTE
The settings for the heating circuit control how the heat pump is switched on and off depending on the temperature.

SETTING THE HEATING CURVES OF MIXING CIRCUIT 1

NOTE
Menu access to the heating curves of mixing circuit 1 is only possible if a mixer is installed in the system and mixing circuit 1 is defined as a discharge mixing circuit in the system setting.

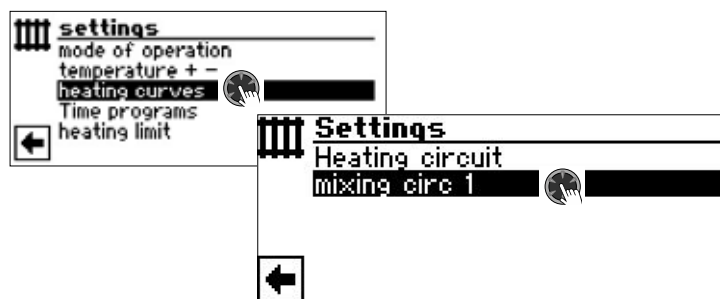

The screen changes to the menu “Heating curves Mixing circuit 1”. The heating curves can be programmed if no fixed temperature is defined.

→ page 19, “Setting a fixed temperature”

Follow the instructions on page 10, “Setting the heating mode of operation”

NOTE
Ensure that you always define flow temperatures when setting the heating curves of mixing circuits.

SETTING A FIXED TEMPERATURE

NOTE
You can only determine a fixed temperature if this option has been selected by the system setting.

→ Part 2 of the controller manual, program area “Service”, chapter “Determining system settings”, “Setting hc” and “Setting mc1”.

NOTE
The fixed temperature is heated to independently of the external temperature.



Fixed temperature heating circuit

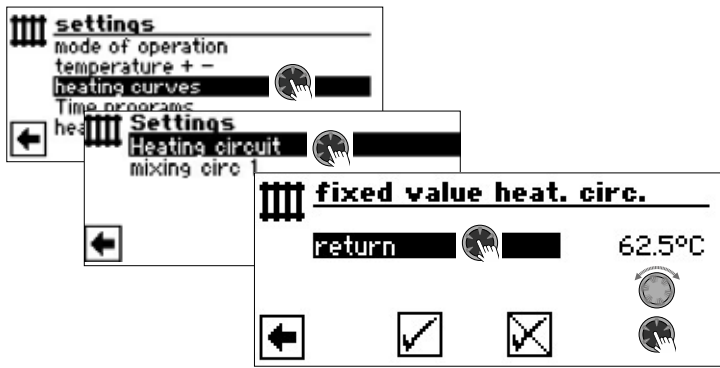

If the option "Fixed temperature" is switched on by the system setting, the screen changes to the menu "Heating curves" (which can take you to the menus "Fixed value heating circuit" or "Fixed value mixing circuit") or directly to the menu "Fixed value heating circuit".

Select menu field "return", set required fixed temperature, save the settings.

NOTE

If "Fixed value" is set and "Heating limit" is set to YES under the system settings, then the heat pump switches off above the heating limit and the HUP is deactivated.

Fixed temperature mixing circuit 1

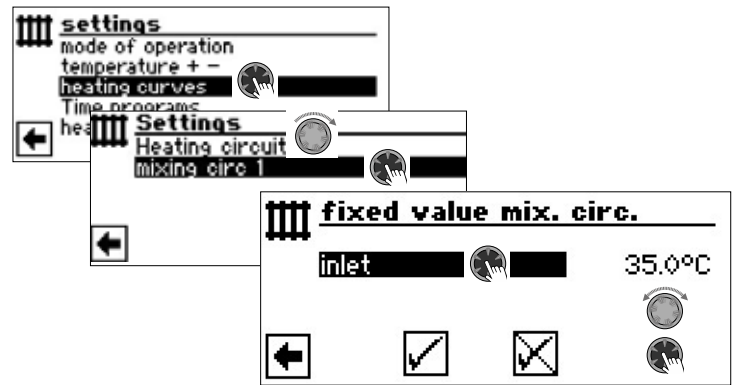

Ist die Option "Festtemperatur" durch die Systemeinstellung eingeschaltet, wechselt der Bildschirm in das Menü "Heizkurven" (von dem ausgehend Sie in die Menüs "Festwert Mischkr. 1" gelangen)

Select menu field "inlet", set required fixed temperature, save the settings.

NOTE

If "Fixed value" is set and "Heating limit" is set to YES under the system settings, then the heat pump switches off above the heating limit and the HUP is deactivated.

If the option "Fixed temperature" is selected by the system setting, the heating curve will typically appear as follows::

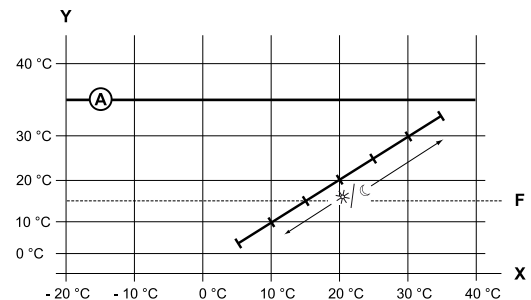

X External temperature

Y "Return temperature"

F Antifreeze

Ⓐ Fixed temperature (here: + 35 °C)

TIME PROGRAM HEATING

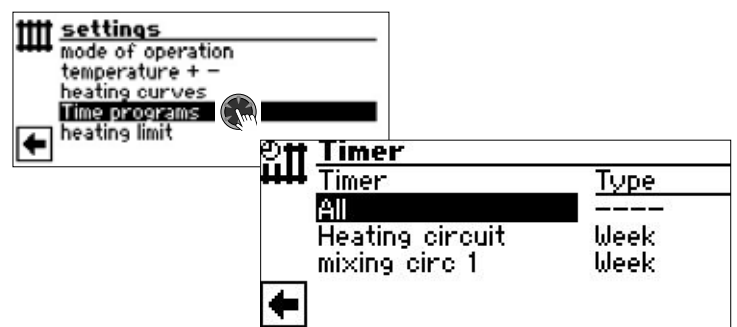

→ page 11, "Setting the time programs of the heating circuit"



HEATING LIMIT

Requirement: the heating limit is set to “yes” under the system settings.

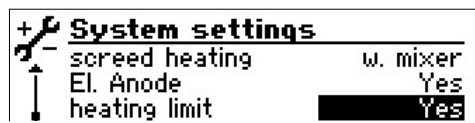

Heating limit = Yes

Heating mode is switched off if the daily mean temperature of the last 24h is higher than the daily meant temperature set as the “heating limit”. Requirement: the heating limit is set to “yes” under the system settings.

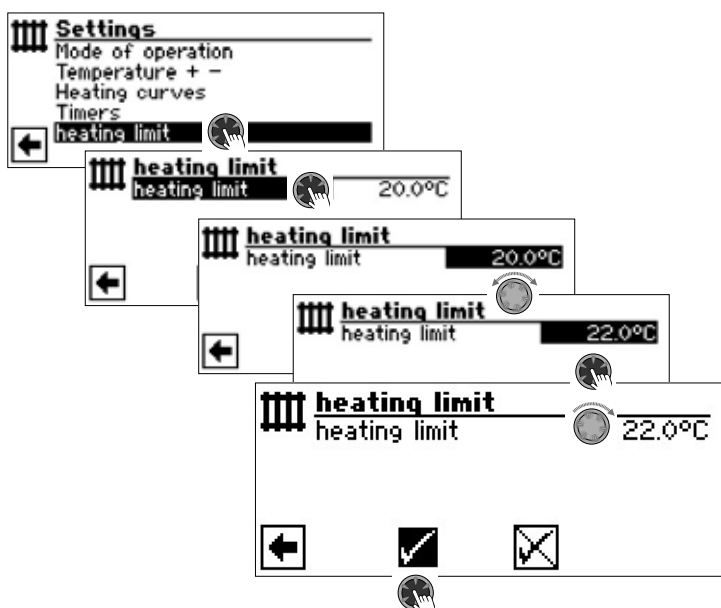

→ For setting the Heating Limit: part 2 of the controller manual, program area “Service”, chapter “Fix system settings”

Program area “Domestic hot water”

SELECT PROGRAM AREA

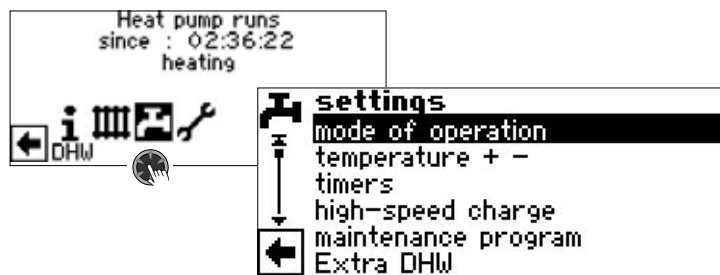

Menu field “Mode of operation”

takes you to the menu “Domestic hot water mode of operation”

Menu field “Temperature + -”

takes you to the menu “Domestic hot water temperature desired value / target temperature” (If the domestic hot water is controlled via a thermostat, this menu field can be omitted.)

Menu field “Timers”

takes you to the menu “Domestic hot water time programs”

Menu field “High-speed charge”

takes you to the menu “Domestic hot water high-speed charge”

Menu field “Maintenance program”

takes you to the menu “Maintenance program”

Menu field “Extra DHW”

only with Luxtronik 2.1 with software version ≥ 3.89

SETTING THE MODE OF OPERATION “DOMESTIC HOT WATER PREPARATION”

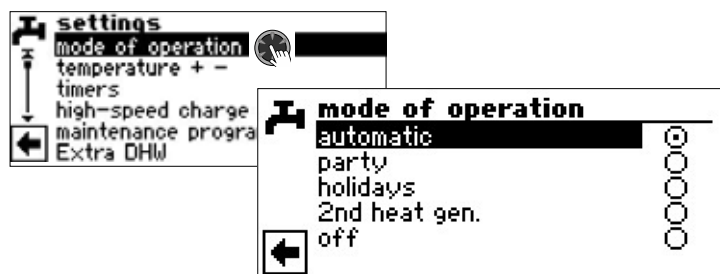

The current mode of operation is highlighted with ●

→ page 13, “Setting the domestic hot water mode of operation”

SET THE DOMESTIC HOT WATER TEMPERATURE

i NOTE

If the domestic hot water preparation is controlled via a thermostat, no temperature fine setting is possible. The menu field “Temperature + -” does not then appear in the screen “Domestic hot water settings”.

i NOTE

If a domestic hot water temperature is set which cannot be attained, the heat pump will initially switch to “Error high pressure”. This is followed by a self-resetting fault (If heating is required, this will also be operated). After 2 hours have passed, the domestic hot water preparation starts



again. Nevertheless, the program of the heating and heat pump regulator automatically lowers the setpoint value for this by an initial 1 °C. If this setpoint temperature cannot be attained either, the process is repeated until a temperature can be attained.

The set desired value remains unaffected and is displayed unchanged.

HOT WATER TEMPERATURE WITHOUT REHEATING (FACTORY SETTING)



Wanted value

Required hot water temperature in the hot water storage tank

Value range: 30 °C – 65 °C, adjustable steps 0,5 °C

Select menu field “Desired value” and set required temperature. Einstellung speichern.

coverage hp

Hot water temperature, which was reached by the heat pump for the last water heating

NOTE

Depending on the heat source temperatures, this can result in the maximum flow temperatures of the heat pump no longer being able to be reached. Depending on the required temperature, this can mean that the required hot water temperature in the storage tank is also no longer reached.

The heat pump switches off automatically if the use limits are exceeded. The last reached temperature in the storage tank is set as the “coverage hp” and at the same time is the control value for the water heating. As soon as the temperature falls below the “coverage hp” control value by the water heating hysteresis (default 2 K), the water heating starts again. If the last reached “coverage hp” value can be reached, the heat pump tries to approach the required value again, in 0.5 K steps. If the temperature is not reached (even outside the hysteresis) the control value “coverage hp” is reduced by 1 K.

NOTE

In conjunction with domestic hot water tanks recommended by the manufacturer, your heat pump can generate domestic hot water temperatures which are around 7 K lower than the maximum flow temperature of your heat pump.

HOT WATER TEMPERATURE WITH REHEATING

If water heating with reheating is activated, if the required hot water temperature cannot be reached with the heat pump, a second heat generator is started up until the target temperature is reached.

NOTE

The “hot water temperature with reheating” function must be enabled first in the “System settings” area:

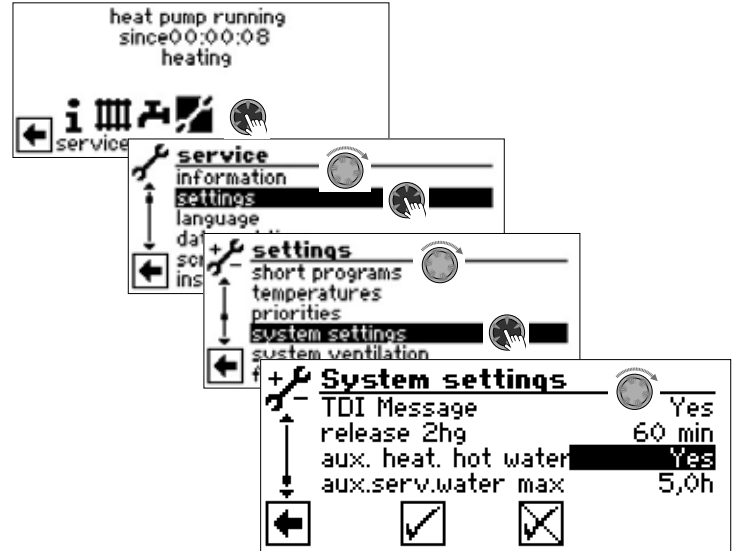

NOTE

Using the “Hot water temperature with reheating” function can possibly cause higher energy costs. Therefore, after this function has been activated you are asked whether you are prepared to accept the higher energy costs.

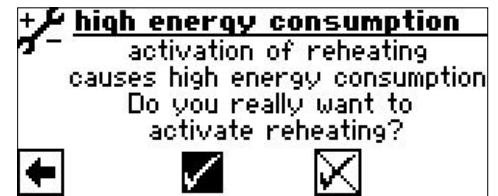

If you confirm this the “Hot water temperature with reheating” function remains activated.

Go to and select to deactivate the “Hot water temperature with reheating” function..

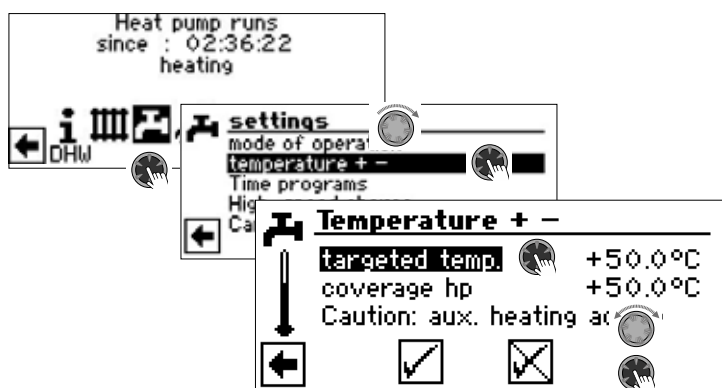

targeted temperature

Target value for the hot water temperature in the domestic hot water storage tank

coverage hp

Hot water temperature reached by the heat pump for the last water heating

NOTE

If the target temperature cannot be reached with pure heat pump operation, the heat pump switches off prematurely. The difference between the “coverage hp” and “targeted temperature” is covered by the second heat generator (e.g. electric heating element) in the storage tank:

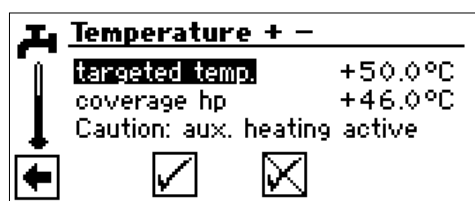

The control value for the water heating is always the parameter “coverage hp”, this means that as soon as the temperature falls below the “coverage hp” control value by the water heating hysteresis (default 2 K), water heating starts again. If the last reached “coverage hp” value can be reached, the heat pump tries to approach the target value again, in 0.5 K steps. If this is not possible, the heat pump switches off and the second heat generator heats the water until the target value is reached.

NOTE

In conjunction with domestic hot water tanks recommended by the manufacturer, your heat pump can generate domestic hot water temperatures which are around 7 K lower than the maximum flow temperature of your heat pump.

TIME PROGRAMS “DOMESTIC HOT WATER PREPARATION”

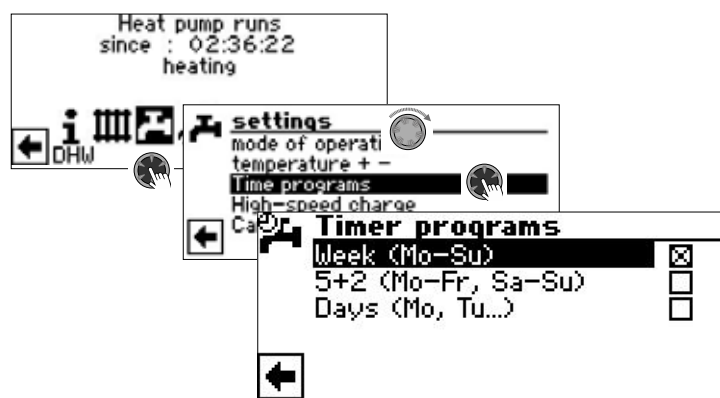

→ For setting the time programs for domestic hot water preparation refer to chapter “Setting the time programs of the heating circuit” (page 11).

NOTE

When programming, ensure that the time periods which you specify in the area “Time progs” are **off – times**. The domestic hot water preparation is switched off in the time periods entered.

HIGH-SPEED CHARGE

If you require domestic hot water despite active off-time(s), you can select a domestic hot water preparation and then terminate it again via the function “High-speed charge” by bypassing the programmed off-time(s).

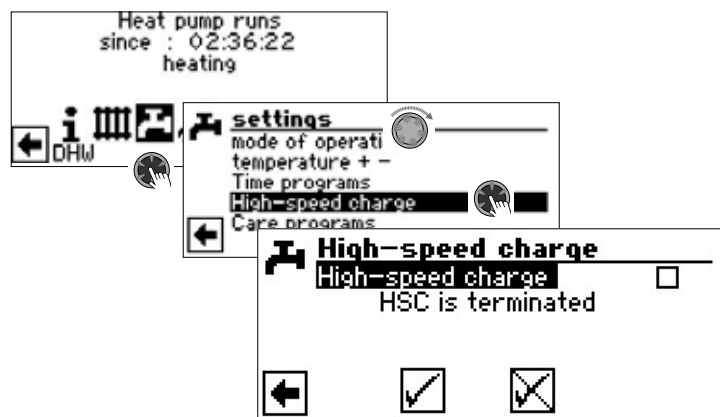

You see the automatic status message of the program



Select the menu field “High-speed charge”. Save the settings.

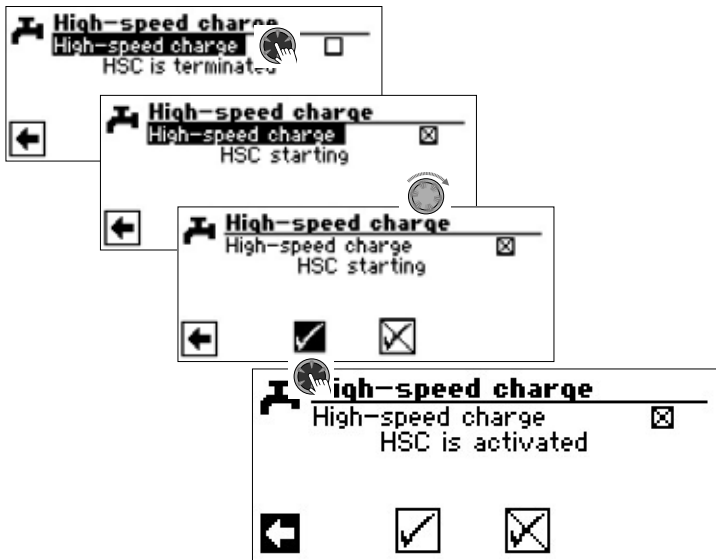

The high-speed charging is terminated analogously:

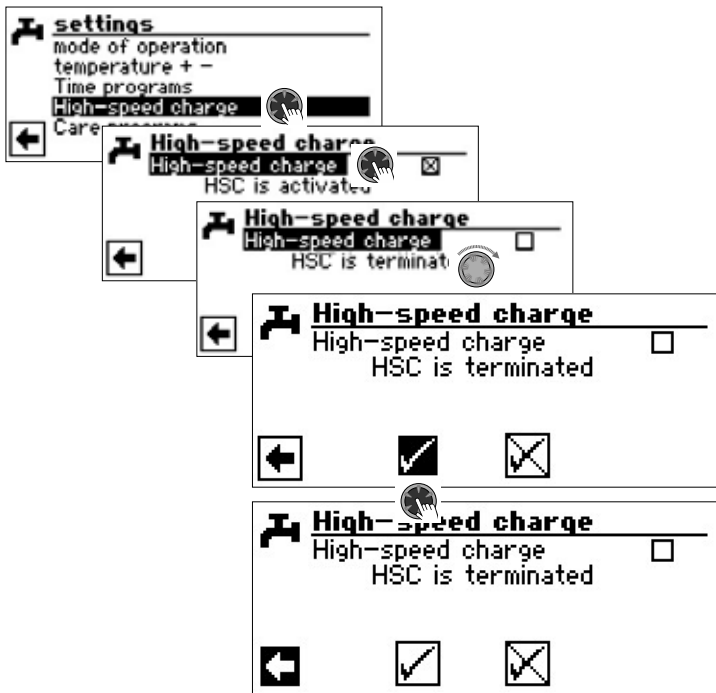

MAINTENANCE PROGRAM

THERMAL DISINFECTION

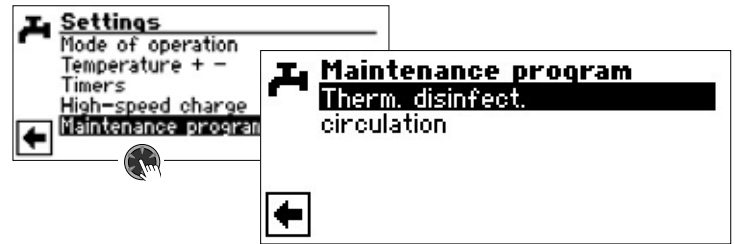

Thermal disinfection makes it possible to raise the temperature of the domestic hot water to a higher temperature than can be reached with a heat pump using a second heat generator (ZWE). The thermal disinfection is prepared exclusively via second heat generators; the compressor of the heat pump remains switched off.

NOTE
The menu field “Therm. disinfect.” will only appear if a second heat generator for domestic hot water preparation has been enabled.

NOTE
Thermal disinfection is not active in the modes “Holidays” and “Off”. It does not start again until the first domestic hot water preparation after the “Vacation” or “Off” operating modes have been ended.

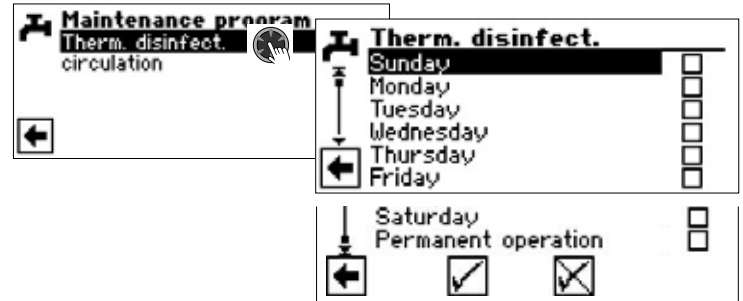

Activate and select day(s) on which a thermal disinfection is to occur.

NOTE
“Permanent operation” means that a thermal disinfection will occur after each domestic hot water preparation. However, domestic hot water preparation only starts if the domestic hot water target temperature has fallen below the set hysteresis:
“Permanent operation” can only be activated if the reheating function is switched off (→ page 22).

Thermal disinfection always starts at 00.00 hrs., even during off time (EVU blocking period).

Thermal disinfection with ZWE 1

Since ZWE 1 is always located in the heat pump supply, the heat pump cannot heat during thermal disinfection. In order to be able to carry out thermal disinfection as quickly as possible, ZWE 1 is therefore released with the heat pump once the target temperature has been reached. The heat pump switches off via the high-pressure pressostat or the max. flow temperature.

When switching off via the high-pressure pressostats, the current flow temperature is stored for less than 1 K and switched off via this value at the next thermal disinfection. The value is cleared when the controller is restarted.

The ZWE 1 then remains switched on until the target temperature of the thermal disinfection is reached. The domestic hot water circulating pump (BUP) runs for the entire time.

Thermal disinfection with ZWE 2

Since the ZWE 2 is always located in the DHW storage tank, the heat pump can heat during thermal disinfection. For this reason, the heat pump only runs up to the set DHW target temperature. The heat pump then switches off and the ZWE 2 is switched on. At this point the domestic hot water circulating pump (BUP) switches off and the heat pump can run in heating operation again.

If the heat pump has already been switched off during thermal disinfection and the DHW target temperature has not yet been reached, the heat pump switches on again (for example with missing ZWE 2 performance).

If the target temperature of the thermal disinfection has not yet been reached within 5 hours, the thermal disinfection is aborted. The heat pump then tries again the next day to reach the target temperature of the thermal disinfection with the described procedure.

CIRCULATION

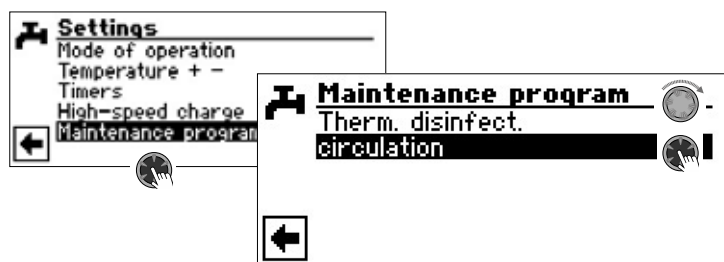

NOTE

The menu field "Circulation" only appears if "Service water" is set to "CP".

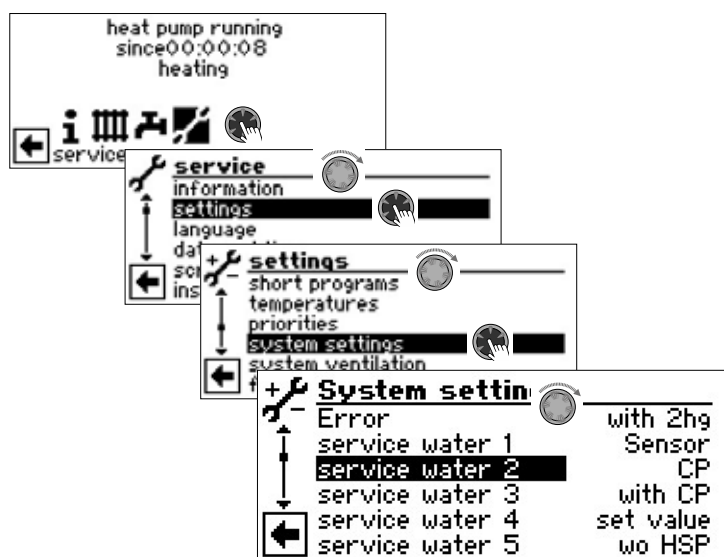

If the "service water 2" menu field under "System settings" is not visible, you must make this setting via the "FlexConfig" menu (OUT 2 = ZIP):

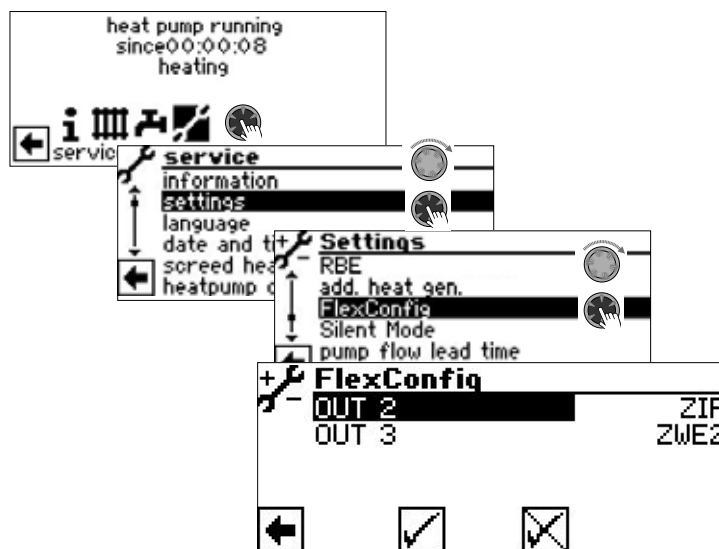

The circulation pump is configured by setting switching times and impulses.

Time switches

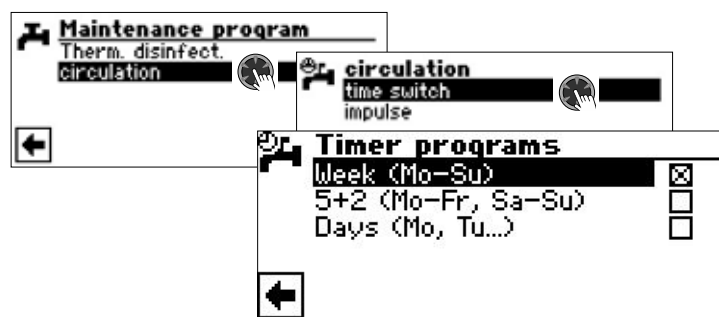

Use the time programs to specify the times during which the circulation pump is to run.

→ For the exact procedure used to set the times, please refer to **chapter** "Setting the time programs of the heating circuit" (page 11).



Impulse

In the "Impulse" menu, you define when the pump is switched on or off within the programmed switching times

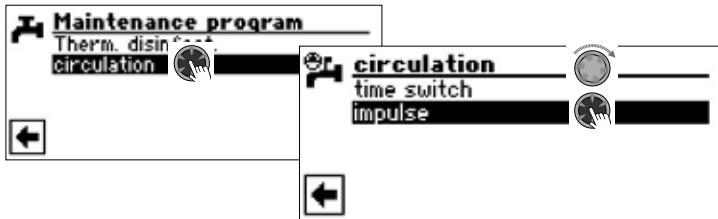

Value range: 5 min (factory setting)
adjustable from 1 - 10 min in 1 min steps
adjustable from 10 - 120 min in 5 min steps

Example 1:

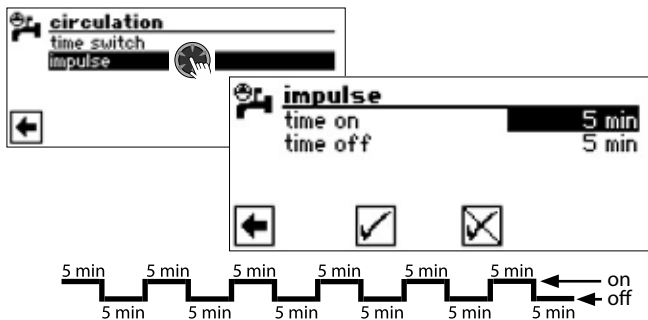

Example 2:

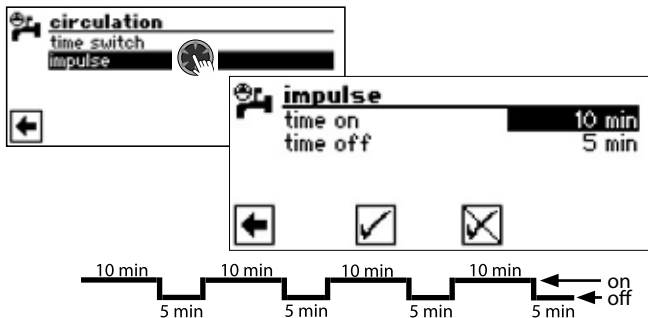

NOTE

If "Time off" is set to 0 minutes, the circulation pump runs continuously during the programmed switching times.

EXTRA DHW

This function is only available with Luxtronik 2.1 with software version ≥ 3.89 .

"Extra DHW" provides the option of raising the domestic hot water temperature to a higher target value (required temperature) for a set period of time.

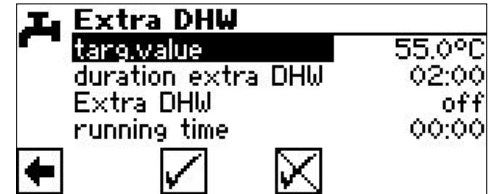
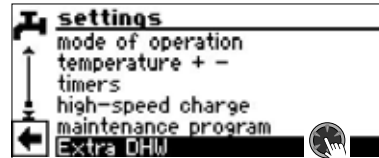

targ.value

Desired target value for the domestic hot water temperature

duration extra DHW

Duration for which the desired target value is to apply

Value range: 0 – 24 h adjustable in 30 m steps

Extra DHW

on = Function is switched on

off = Function is switched off

running time

Time that has elapsed since the function was switched on. The time only elapses after the settings have been saved

Save settings.



After the duration set under "Duration extra DHW" has elapsed, the function is automatically switched off. The desired target value set here in this menu is no longer taken into account for domestic hot water preparation.

If this desired target value for domestic hot water preparation is to apply again for the duration set, "Extra DHW" must be set to "on" again. This setting must be saved again.



NOTE

High domestic hot water temperatures in the storage tank reduce the system's efficiency, increase stoppage losses in the storage tank and therefore increase running costs. Specific national requirements must be met.

NOTE

If off-times for the preparation of domestic hot water are set, these are ignored for the set duration of the function "Extra DHW".



Program area "Service"

CALLING UP PRESET PROGRAMS

The preset programs serve to make service work easier.

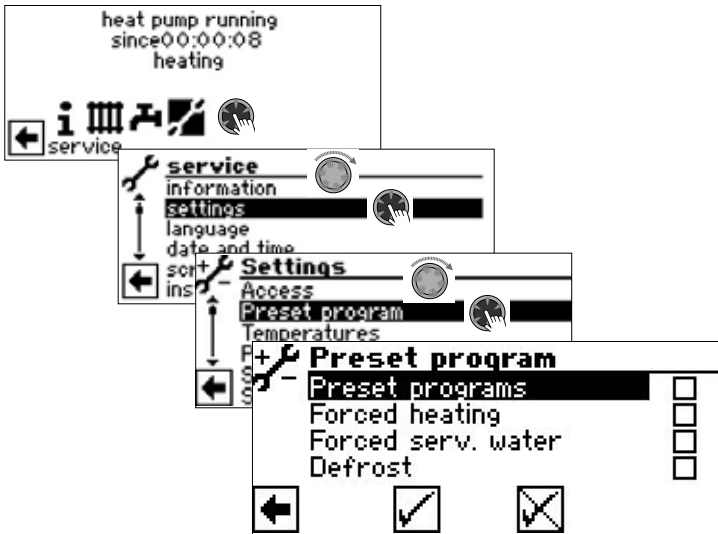

Preset programs

Shortens the switching cycle stop and releases the heat pump.

Forced heating

Program settings are ignored. Heating requirement up to high pressure. After a high pressure fault, the menu field "Forced heating" is automatically deselected and reset.

Forced serv. water

Function analogous to "Forced heating".

Defrost

Menu field only appears for air/water heat pumps.

The defrost function of the heat pump can be tested with this.



NOTE

After 3 hours the respective preset program is automatically switched off.

DETERMINING PRIORITIES



Priority is determined by the sequence of numbers.



NOTE

Domestic hot water preparation – as in the example – has top priority in the factory setting.

If you wish to give the heating priority, Menüfeld "Warmwasser" aktivieren und Priorität ändern. Priorität für "Heizung" wird automatisch auf 1 gesetzt.

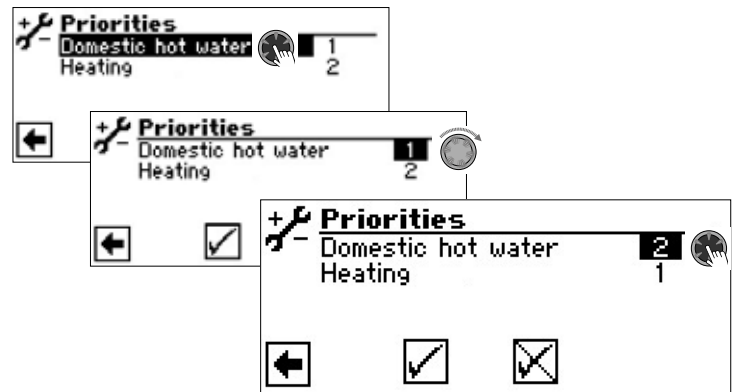

Save settings.



DATA LOGGER

The controller is equipped with a data logger which records the data of the heat pump for a period of 48 hours (temperatures, inputs/outputs). You can save this data to a USB stick. To do so, insert the USB stick into the controller and use the menu item data logger to save the data to the USB stick.

An authorised customer service or fitter can start a permanent data logger function using his or her password access. If the USB stick is inserted, the data including date and time will then be stored automatically every 48 hours.

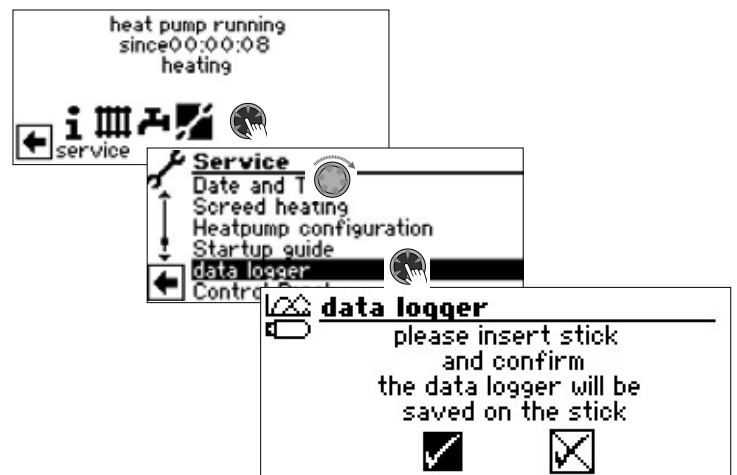

NOTE

Please remember to save the data logger to the USB stick before removing the USB stick from the control unit. You will otherwise lose the most recent values.



CONTROL PANEL

WEB SERVER

The left socket at the bottom of the control unit can be used to connect to a computer or a network, enabling the heating and heat pump regulator to be controlled remotely from there.

This requires the laying of a screened network cable (category 6) through the unit during the electrical connection work. If this network cable is available, insert the network cable's RJ 45 plug into the left socket of the control unit.

Variant 1^{*)}

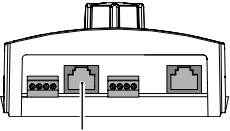

Variant 2^{*)}

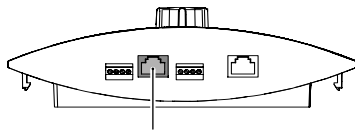

^{*)} The variant is device-dependent

The "Web server" function allows you to use a computer and an Internet browser to control the heating and heat pump regulator.

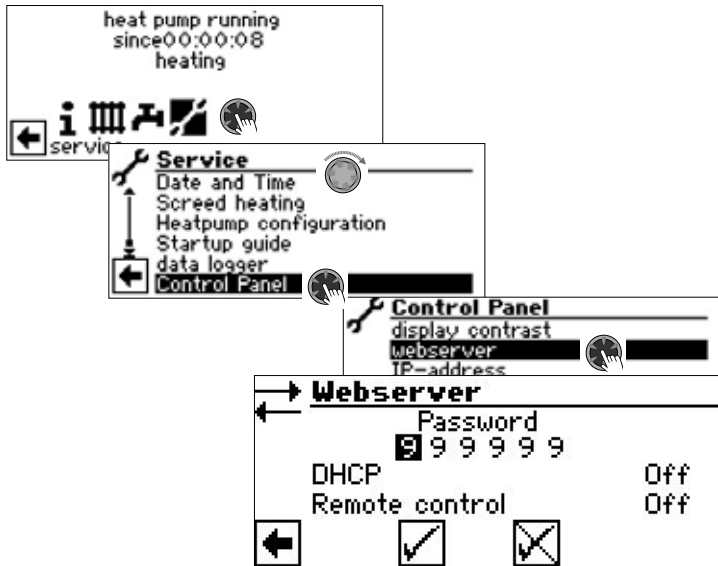

Access to data input is enabled by default by password 999999. However, you can assign your own password (6-digit number sequence).

You will need this password later to register the computer with the controller. If you enter an incorrect numeric password, you will only be able to read data, but not make any changes.

If the heating and heat pump control is connected to the Internet, ensure that it is protected against attacks and unauthorised access by a router or firewall.

Activation of incoming connections from the Internet is generally not required. Only if remote maintenance is used must the ports specified by the manufacturer be enabled for the heating and heat pump control.

→ Part 2 of the manual of the Heating- and Heatpump Control, Program area "Service", chapter "Remote maintenance"

NOTE

For operation in company networks or in municipal networks, the use of a separate local network or a VLAN is recommended.

NOTE

If the heating and heat pump control is connected to the Internet, regularly check whether it is being operated with the latest software version. If necessary, carry out a software update.

→ Part 2 of the manual of the Heating- and Heatpump Control, chapter "Softwareupdate / -downgrade"

DHCP Server

If the computer is connected directly to the heating and heat pump regulator, enable the menu item "DHCP Server".

The computer connected as a DHCP client will automatically be assigned an IP address.

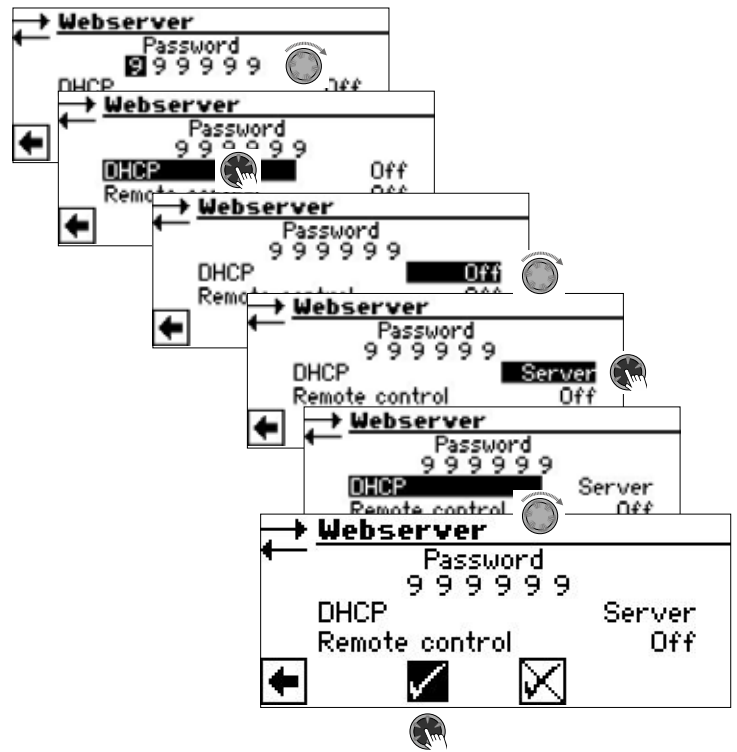

NOTE

A computer connected directly to the heating and heat pump controller must work as a DHCP client. This means that the computer automatically receives all the necessary connection data from the DHCP server of the heating and heat pump controller.

In the event of any connection problems, check the network settings of the operating system installed on your computer and adjust the settings if necessary.

NOTE

If the DHCP option "Server" is set (or deactivated), this always requires a restart of the heating and heat pump controller (reset).



DHCP Client

If the heating and heat pump controller is to be integrated into a network with a DHCP server (e.g. router), the DHCP option "Client" must be set in the DHCP option.



The heating and heat pump controller then obtains its connection data automatically from the DHCP server (e.g. router).

Remote control

If the "Remote control" option is activated, the heating and heat pump controller can be controlled via a computer or a network. The settings of the heating and heat pump controller are then not only readable, but also changeable.

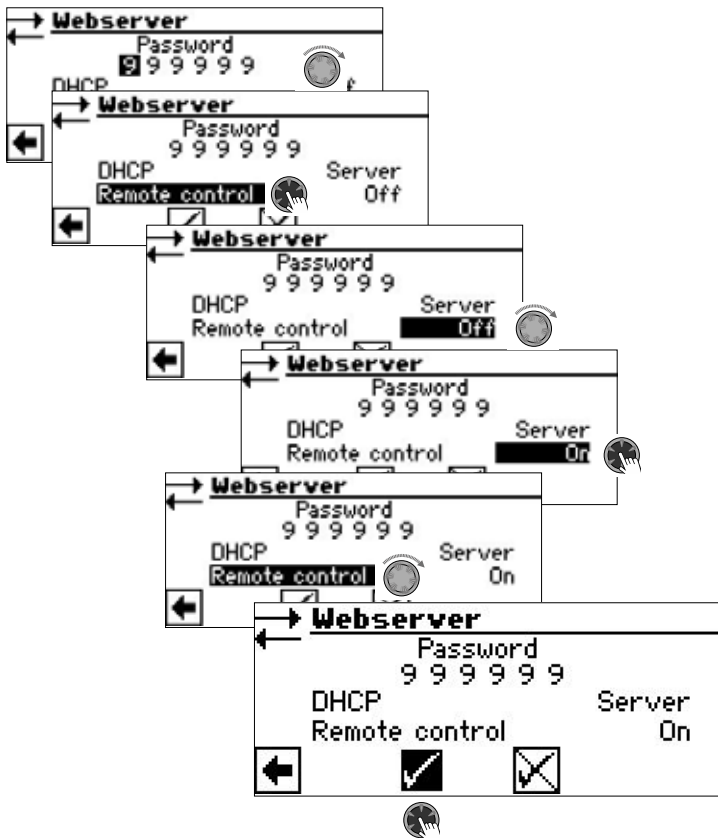

NOTE

If the heating and heat pump controller is connected to a network with a DHCP server (e.g. router), the DHCP option "Client" must be set – in contrast to the one shown above.

IP-address

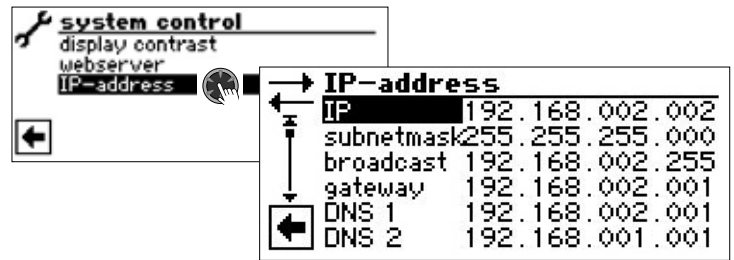

IP	IP address of the heating and heat pump regulator
Subnetmsk.	Subnet mask
Broadcast	Address Broadcast
Gateway	Gateway address of the connected router
DNS 1	Address of the DNS server 1
DNS 2	Address of the DNS server 2

If DHCP is set as "Server" or "Client" in the heating and heat pump controller, the connection data can only be read.

Connection data can be changed manually if DHCP in the heating and heat pump controller is set to "Off".

To access the heating and heat pump controller remotely, open an internet browser on a computer connected directly or through a network and enter "http://" in the address bar, then the number appearing on the IP address screen of your heating and heat pump controller under "IP".

To assign a fixed IP address to the heating and heat pump controller in a network, set DHCP to "Off" and enter the connection data manually according to the network data (subnet mask, broadcast, gateway).

Example:

The IP address of the connected router (= gateway) is 192.168.2.1, and the number of the subnet mask is 255.255.255.0.

You will then first have to enter and save the following address data in the heating and heat pump regulator:

IP	192.168.002.002
subnetmask	255.255.255.000
broadcast	192.168.002.255
gateway	192.168.002.001



NOTE

The IP given here is an example. The address must be within the address range of the broadcast and gateway. In this example, 002 to 254 are permitted as the last digits, provided they are not yet assigned to any other device managed by the connected router.



Then you must set the address data of the DNS servers you want to use. Example:

DNS 1	192.168.002.001
DNS 2	192.168.001.002

NOTE
The DNS 2 address is used if the DNS 1 address is not accessible in the meantime.

Save settings.



NOTE
On a mobile device (Smartphone, tablet), the heat pump can also be accessed in the local home network via the "alpha connect" app. If you have an "alpha web" user account, this access is also possible from the worldwide internet via a mobile device or a computer.





alpha innotec

ait-deutschland GmbH
Industriestraße 3
95359 Kasendorf
Germany

T • +49 9228 / 9906-0
F • +49 9228 / 9906-189
E • info@alpha-innotec.de

www.alpha-innotec.com

alpha innotec – an ait-deutschland GmbH brand

Subject to technical amendments without prior notice.